

# PART SOLUTIONS

mex



10/2004

**US** Content of the CAD catalog in PARTsolutions.  
For more catalogues visit [www.cadenas.de](http://www.cadenas.de)

**D** Inhalt des CAD-Kataloges in PARTsolutions.  
Weitere Kataloge auf [www.cadenas.de](http://www.cadenas.de)

**F** Contenu du catalogue CAO dans PARTsolutions.  
Pour d'autres catalogues visitez [www.cadenas.de](http://www.cadenas.de)

**I** Contenuto del catalogo nel PARTsolutions  
altri cataloghi visitate [www.cadenas.de](http://www.cadenas.de)

**E** Contenido del catálogo de CAD en PARTsolutions.  
Para mas catálogos visite [www.cadenas.de](http://www.cadenas.de)

# INFORMATION



With PARTsolutions you are able to access a large range of standard and supplier parts as CAD system independent 2D and 3D geometry. Independent means the models are converted natively in practically every CAD system. When using CATIA for example, a real CATIA model will be generated from our model and can of course be edited and manipulated for downstream applications. Interfaces are available for all common CAD systems (see list below).

Integrations also exist to the most notable ERP/PDM systems (see list below).



Mit PARTsolutions steht Ihnen eine grosse Anzahl Normteile und Zukaufteile als CAD unabhängige 3D und 2D Geometrie zur Verfügung. Unabhängig heisst, sie können in jedes CAD System nativ übertragen werden. Der User von PARTsolutions erhält so in Verbindung mit z.B. CATIA ein echtes CATIA-Modell, das in seiner Konstruktion dann selbstverständlich weitermodelliert werden kann. Schnittstellen für jedes gängige CAD System sind verfügbar (siehe Liste unten).

In weiteren Ausbaustufen sind auch Anbindungen an ERP/PDM Systeme möglich (siehe Liste unten).



Avec PARTsolutions vous avez à votre disposition un grand nombre de composants normalisés et de pièces d'achat comme géométrie CAO indépendante du 2D et 3D. Indépendant veut dire qu'ils peuvent être transmis nativement dans presque tous les systèmes CAO. Ainsi l'utilisateur de PARTsolutions obtient une liaison avec un vrai modèle CATIA, en prenant CATIA comme exemple, qui peut être naturellement continuellement modélisé dans sa construction. Des interfaces pour tous les systèmes CAO courants sont disponibles (voir la liste ci-dessous).

Dans d'autres degrés d'extension, des liaisons avec des systèmes ERP/PDM sont aussi possibles (voir la liste ci-dessous).



Con PARTsolutions è possibile accedere a una grande quantità di parti standard e commerciali sotto forma di geometria 2D e 3D indipendente dal sistema CAD. Ciò significa che i modelli vengono convertiti nel formato nativo di praticamente tutti i sistemi CAD in commercio. Usando per esempio CATIA, viene generato un vero modello CATIA che può essere modificato e manipolato per successivi utilizzi. Le interfacce CAD disponibili sono elencate qui sotto.

Esistono anche integrazioni coi principali sistemi ERP/PDM (vedere la lista qui sotto).



Con PARTsolutions tiene a su disposición un gran número de estándares y normas de la industria como un sistema CAD de geometría independiente 2D y 3D. Independiente significa que se pueden transmitir de forma nativa a prácticamente en todos los sistemas CAD. El usuario de PARTsolutions posee de este modo en el uso por ejemplo de CATIA un modelo original de CATIA, en el cual por supuesto se puede seguir modelando. Interfaces para cada sistema CAD disponible son disponibles (ver lista abajo).

También son posibles integraciones para sistemas ERP/PDM (ver lista abajo)

## Native CAD formats:

ADEM, AllPlan, AutoCad, Bihler CAT, Cadceus, Caddy, CADISON, Cadkey, Cadra, Catia, CCD/ProfCADAM, Cimatron, Fides, Helix, HiCAD, Ideas, Inventor, Logocad Triga, Mastercam, Materialise, Mechanical Desktop, Medusa, MegaCAD, Microstation, One Space Designer, Parasolid, ProE, SolidDesigner, SolidEdge, SolidWorks, Swiss Precision, Thinkdesign, TopSolid, Unigraphics, Varimetrix, Visi Series.

## Neutral CAD formats:

SAT, STEP, IGES, DXF.

## ERP/PDM Systeme:

SAP, Teamcenter, smarteam, Windchill, Insight, Compass, Gain, ProCad, Eigner. Weitere Schnittstellen auf Anfrage.

# PARTsolutions

1



1.1



1.2

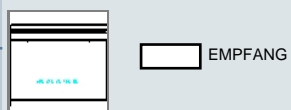

1.3



1.4



1.5

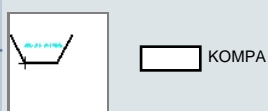

1.6



1.7

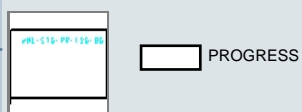

1.8



1.9



1.10



# PARTsolutions

1.11

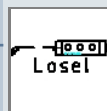

Losel

ZUBEHOER

2



SCHRANKE

2.1

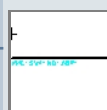

NORMA

2.2

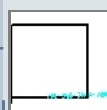

SYSTEMA

2.2.1



42-TIEFE

2.2.2



BLENDEN

2.2.3

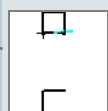

GLEIT-42

2.2.4



REG-SIDE

2.3

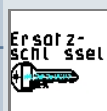

Ersatz-  
schlüssel

ZUBEHOER

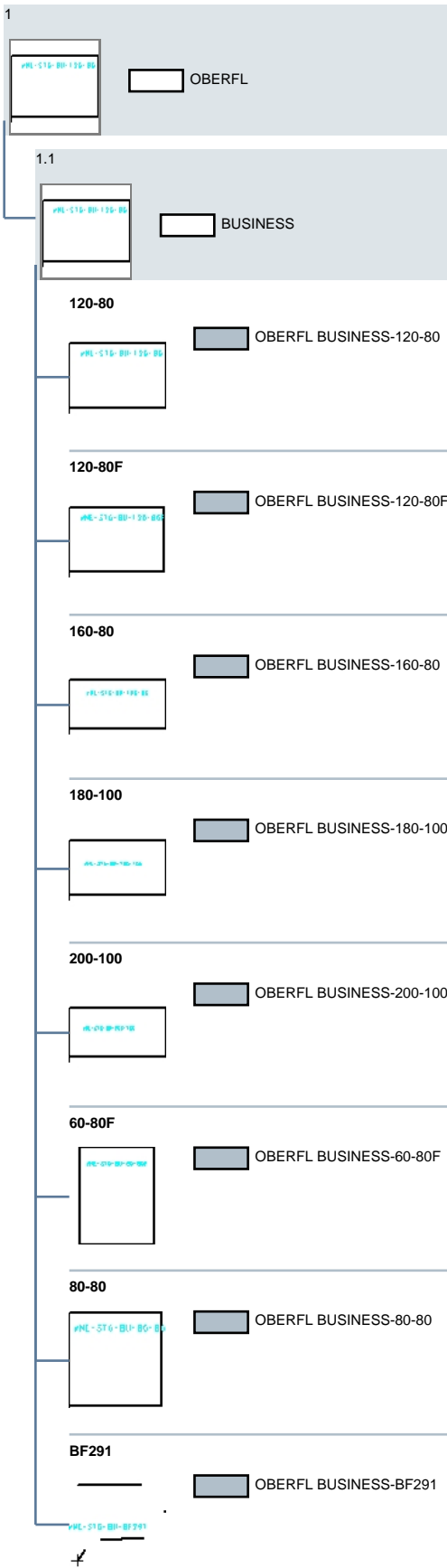

# PARTsolutions

1

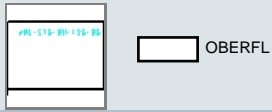

1.1

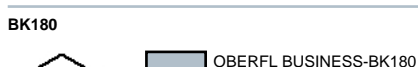
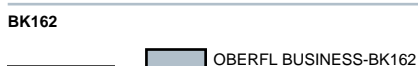
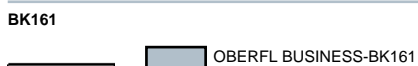
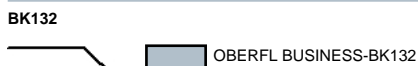
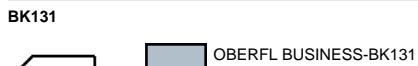
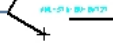
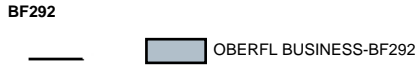
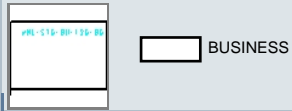

# PARTsolutions

1



1.1



BK181

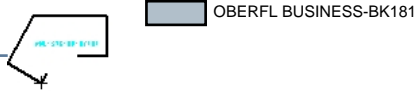

BK182

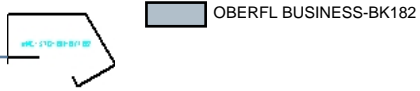

BK251

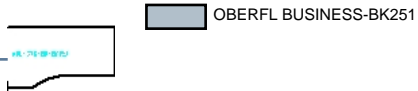

BK252

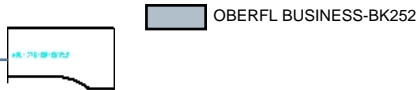

BK261

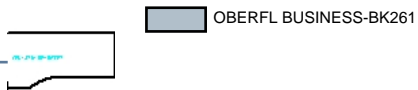

BK262

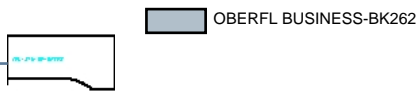

BK351

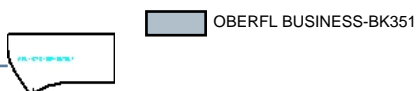

BK352

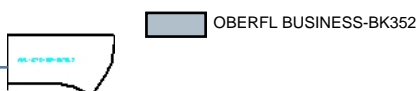

# PARTsolutions

1

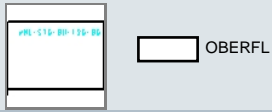

1.1



BK361

OBERFL BUSINESS-BK361



BK362

OBERFL BUSINESS-BK362



CO8L-81

OBERFL BUSINESS-CO8L-81



CO8L-82

OBERFL BUSINESS-CO8L-82



CO8L-83

OBERFL BUSINESS-CO8L-83



CO8R-81

OBERFL BUSINESS-CO8R-81



CO8R-82

OBERFL BUSINESS-CO8R-82



CO8R-83

OBERFL BUSINESS-CO8R-83





1

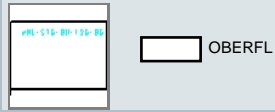

1.1



CPU



ENDFL

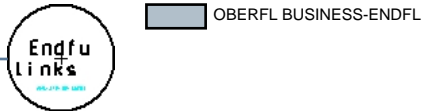

ENDFR

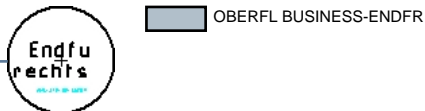

KK

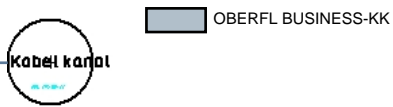

KURZFL

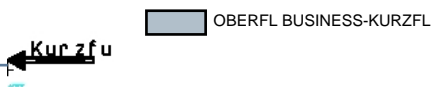

KURZFR

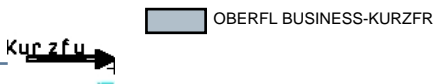

KW

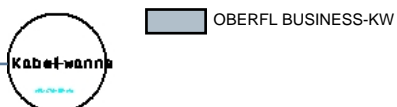

MONT

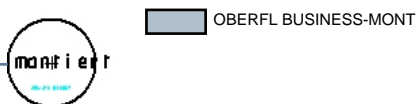

1

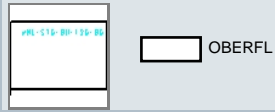

1.1

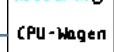
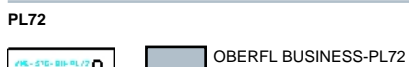
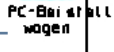
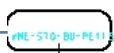
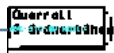

# PARTsolutions

1

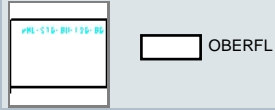

OBERFL

1.1



BUSINESS

PL80



OBERFL BUSINESS-PL80

PL82



OBERFL BUSINESS-PL82

PV18



OBERFL BUSINESS-PV18

PZ80

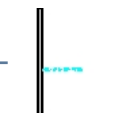

OBERFL BUSINESS-PZ80

PZ81



OBERFL BUSINESS-PZ81

RWB-120



OBERFL BUSINESS-RWB-120

RWB-120F



OBERFL BUSINESS-RWB-120F

RWB-140



OBERFL BUSINESS-RWB-140

1

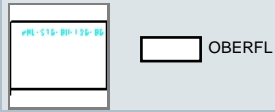

1.1



RWB-160

OBERFL BUSINESS-RWB-160

RWB-180

OBERFL BUSINESS-RWB-180

RWB-200

OBERFL BUSINESS-RWB-200

RWB-60F

OBERFL BUSINESS-RWB-60F

RWB-80

OBERFL BUSINESS-RWB-80

ST8L-81

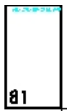

OBERFL BUSINESS-ST8L-81

ST8L-82

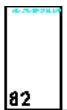

OBERFL BUSINESS-ST8L-82

ST8L-83

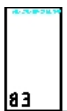

OBERFL BUSINESS-ST8L-83

1

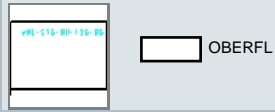

OBERFL

1.1



BUSINESS

ST8L-84

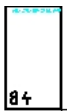

OBERFL BUSINESS-ST8L-84

ST8R-81

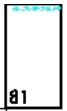

OBERFL BUSINESS-ST8R-81

ST8R-82

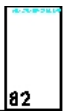

OBERFL BUSINESS-ST8R-82

ST8R-83

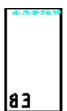

OBERFL BUSINESS-ST8R-83

ST8R-84

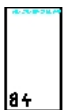

OBERFL BUSINESS-ST8R-84

STEHPL



OBERFL BUSINESS-STEHPL

STEHPR

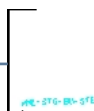

OBERFL BUSINESS-STEHPR

STFUSS



OBERFL BUSINESS-STFUSS

# PARTsolutions

1

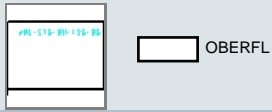

1.1

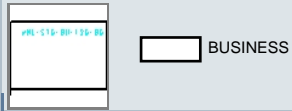

SZ20



SZ22



V-270



V-4X80D



V-90ECK



V-FLUL



V-FLUR



V-HK



1



1.1



### V-TROPF

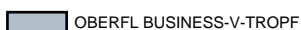

### VS-KONF

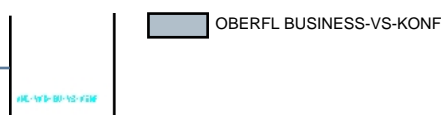

### VS-STERN

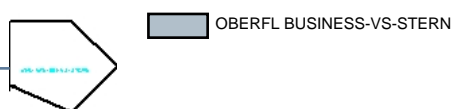

### W90B



1.2

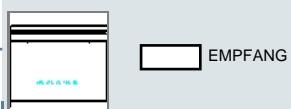

### 120-80

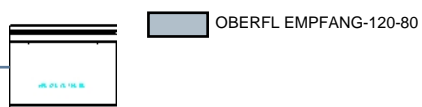

### 160-80

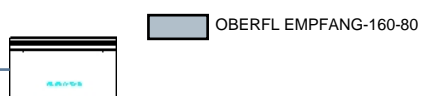

### 160-80E



# PARTsolutions

1



OBERFL

1.2



EMPFANG

80-80



OBERFL EMPFANG-80-80

B45



OBERFL EMPFANG-B45

B90



OBERFL EMPFANG-B90

CO-GGW



OBERFL EMPFANG-CO-GGW

CO-ROLL



OBERFL EMPFANG-CO-ROLL

END-L



OBERFL EMPFANG-END-L

END-R



OBERFL EMPFANG-END-R

ERSCH-ZV



OBERFL EMPFANG-ERSCH-ZV



# PARTsolutions

1

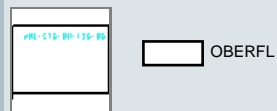

1.2

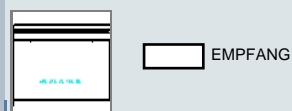

**KOMBI1**



**KOMBI10**



**KOMBI11**



**KOMBI12**



**KOMBI13**



**KOMBI14**



**KOMBI15**



**KOMBI16**



# PARTsolutions

1



OBERFL

1.2



EMPFANG

**KOMBI17**

OBERFL EMPFANG-KOMBI17



**KOMBI18**

OBERFL EMPFANG-KOMBI18



**KOMBI19**

OBERFL EMPFANG-KOMBI19



**KOMBI2**

OBERFL EMPFANG-KOMBI2



**KOMBI3**

OBERFL EMPFANG-KOMBI3



**KOMBI4**

OBERFL EMPFANG-KOMBI4



**KOMBI5**

OBERFL EMPFANG-KOMBI5



**KOMBI6**

OBERFL EMPFANG-KOMBI6



# PARTsolutions

1



OBERFL

1.2



EMPFANG

**KOMBI7**

OBERFL EMPFANG-KOMBI7



**KOMBI8**

OBERFL EMPFANG-KOMBI8



**KOMBI9**

OBERFL EMPFANG-KOMBI9



**LC81-L**

OBERFL EMPFANG-LC81-L



**LC81-R**

OBERFL EMPFANG-LC81-R



**LC82-L**

OBERFL EMPFANG-LC82-L



**LC82-R**

OBERFL EMPFANG-LC82-R



**LC83-L**

OBERFL EMPFANG-LC83-L



1



OBERFL

1.2



EMPFANG

LC83-R

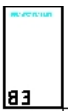

OBERFL EMPFANG-LC83-R

RC62-L



OBERFL EMPFANG-RC62-L

RC62-R



OBERFL EMPFANG-RC62-R

RC63-L



OBERFL EMPFANG-RC63-L

RC63-R



OBERFL EMPFANG-RC63-R

RC67-L



OBERFL EMPFANG-RC67-L

RC67-R



OBERFL EMPFANG-RC67-R

RC68-L



OBERFL EMPFANG-RC68-L

# PARTsolutions

1

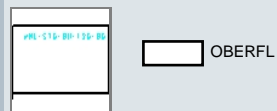

1.2

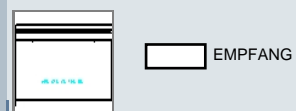

**RC68-R**



**STFUSS**



**V-4X80D**



**V-90ECK**



**VPLATTE**



**VS-STERN**



**W45**



**W90**



# PARTsolutions

1



OBERFL

1.3



FINESSA

100-90



OBERFL FINESSA-100-90

100-90K



OBERFL FINESSA-100-90K

100-90L



OBERFL FINESSA-100-90L

100-90R



OBERFL FINESSA-100-90R

120-90L



OBERFL FINESSA-120-90L

120-90LL



OBERFL FINESSA-120-90LL

120-90R



OBERFL FINESSA-120-90R

120-90RR



OBERFL FINESSA-120-90RR

# PARTsolutions

1



OBERFL

1.3



FINESSA

140-90L



OBERFL FINESSA-140-90L

140-90LL



OBERFL FINESSA-140-90LL

140-90R



OBERFL FINESSA-140-90R

140-90RR



OBERFL FINESSA-140-90RR

80-90



OBERFL FINESSA-80-90

80-90K



OBERFL FINESSA-80-90K

80-90L



OBERFL FINESSA-80-90L

80-90R



OBERFL FINESSA-80-90R

# PARTsolutions

1

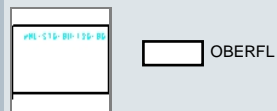

OBERFL

1.3



FINESSA

AFUSS-L



OBERFL FINESSA-AFUSS-L

AFUSS-R



OBERFL FINESSA-AFUSS-R

B-200



OBERFL FINESSA-B-200

B-220



OBERFL FINESSA-B-220

B-230



OBERFL FINESSA-B-230

B-250



OBERFL FINESSA-B-250

B-80



OBERFL FINESSA-B-80

CO8L-81



OBERFL FINESSA-CO8L-81



# PARTsolutions

1



OBERFL

1.3



FINESSA

CO8L-82

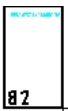

OBERFL FINESSA-CO8L-82

CO8L-83

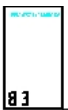

OBERFL FINESSA-CO8L-83

CO8R-81

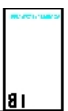

OBERFL FINESSA-CO8R-81

CO8R-82

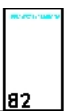

OBERFL FINESSA-CO8R-82

CO8R-83

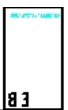

OBERFL FINESSA-CO8R-83

COSTFU-L



OBERFL FINESSA-COSTFU-L

COSTFU-R



OBERFL FINESSA-COSTFU-R

CPU



OBERFL FINESSA-CPU

# PARTsolutions

1



OBERFL

1.3



FINESSA

DB-180



OBERFL FINESSA-DB-180

FD840



OBERFL FINESSA-FD840

FD841



OBERFL FINESSA-FD841

FD842



OBERFL FINESSA-FD842

FD950



OBERFL FINESSA-FD950

FD951



OBERFL FINESSA-FD951

FD952



OBERFL FINESSA-FD952

KK-120



OBERFL FINESSA-KK-120

# PARTsolutions

1



OBERFL

1.3



FINESSA

KK-160



OBERFL FINESSA-KK-160

KK-FUSS



OBERFL FINESSA-KK-FUSS

KOMBI1



OBERFL FINESSA-KOMBI1

KOMBI10



OBERFL FINESSA-KOMBI10

KOMBI11



OBERFL FINESSA-KOMBI11

KOMBI12



OBERFL FINESSA-KOMBI12

KOMBI13



OBERFL FINESSA-KOMBI13

KOMBI14



OBERFL FINESSA-KOMBI14

# PARTsolutions

1

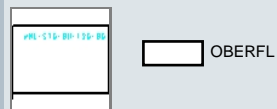

1.3



**KOMBI15**



OBERFL FINESSA-KOMBI15

**KOMBI16**



OBERFL FINESSA-KOMBI16

**KOMBI17**



OBERFL FINESSA-KOMBI17

**KOMBI18**



OBERFL FINESSA-KOMBI18

**KOMBI19**



OBERFL FINESSA-KOMBI19

**KOMBI2**



OBERFL FINESSA-KOMBI2

**KOMBI20**



OBERFL FINESSA-KOMBI20

**KOMBI21**



OBERFL FINESSA-KOMBI21

# PARTsolutions

1



OBERFL

1.3



FINESSA

**KOMBI22**

OBERFL FINESSA-KOMBI22



**KOMBI23**

OBERFL FINESSA-KOMBI23



**KOMBI24**

OBERFL FINESSA-KOMBI24



**KOMBI25**

OBERFL FINESSA-KOMBI25



**KOMBI26**

OBERFL FINESSA-KOMBI26



**KOMBI27**

OBERFL FINESSA-KOMBI27



**KOMBI28**

OBERFL FINESSA-KOMBI28



**KOMBI29**

OBERFL FINESSA-KOMBI29



# PARTsolutions

1



OBERFL

1.3



FINESSA

KOMBI3



OBERFL FINESSA-KOMBI3

KOMBI30



OBERFL FINESSA-KOMBI30

KOMBI31



OBERFL FINESSA-KOMBI31

KOMBI32



OBERFL FINESSA-KOMBI32

KOMBI33



OBERFL FINESSA-KOMBI33

KOMBI34



OBERFL FINESSA-KOMBI34

KOMBI35



OBERFL FINESSA-KOMBI35

KOMBI4



OBERFL FINESSA-KOMBI4

# PARTsolutions

1

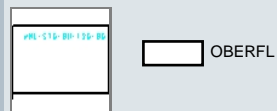

1.3



**KOMBI5**



**KOMBI6**



**KOMBI7**



**KOMBI8**



**KOMBI9**



**RWB-160**



**RWB-180**



**SB-160**



# PARTsolutions

1



OBERFL

1.3



FINESSA

SB-180



OBERFL FINESSA-SB-180

SFUSS-L



OBERFL FINESSA-SFUSS-L

SFUSS-R



OBERFL FINESSA-SFUSS-R

ST8L-181

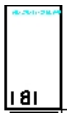

OBERFL FINESSA-ST8L-181

ST8L-182

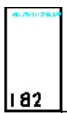

OBERFL FINESSA-ST8L-182

ST8L-183



OBERFL FINESSA-ST8L-183

ST8L-184

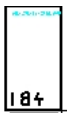

OBERFL FINESSA-ST8L-184

ST8R-181

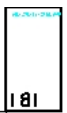

OBERFL FINESSA-ST8R-181



1



OBERFL

1.3



FINESSA

ST8R-182



OBERFL FINESSA-ST8R-182

ST8R-183



OBERFL FINESSA-ST8R-183

ST8R-184



OBERFL FINESSA-ST8R-184

SY-VB75



OBERFL FINESSA-SY-VB75

SZ51



OBERFL FINESSA-SZ51

SZ59



OBERFL FINESSA-SZ59

TZ91



OBERFL FINESSA-TZ91

TZ92



OBERFL FINESSA-TZ92

1

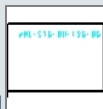

OBERFL

1.3



FINESSA

TZ93



OBERFL FINESSA-TZ93

TZ94



OBERFL FINESSA-TZ94

V-CONT



OBERFL FINESSA-V-CONT

V-ST



OBERFL FINESSA-V-ST

1.4

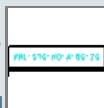

KOMET

A-80-20

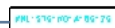

OBERFL KOMET-A-80-20

A160-20



OBERFL KOMET-A160-20

CO8L-81



OBERFL KOMET-CO8L-81

# PARTsolutions

1

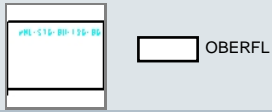

1.4

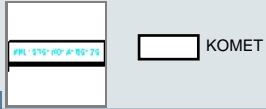

CO8L-82



OBERFL KOMET-CO8L-82

CO8L-83



OBERFL KOMET-CO8L-83

SAULENEC



OBERFL KOMET-SAULENEC

ST8L-81



OBERFL KOMET-ST8L-81

ST8L-82



OBERFL KOMET-ST8L-82

ST8L-83



OBERFL KOMET-ST8L-83

ST8L-84



OBERFL KOMET-ST8L-84

STFUSS



OBERFL KOMET-STFUSS

1



OBERFL

1.4



KOMET

SY-VB75



OBERFL KOMET-SY-VB75

TA-W45

OBERFL KOMET-TA-W45

V-FLUL



OBERFL KOMET-V-FLUL

V-FLUR



OBERFL KOMET-V-FLUR

1.5



KOMPA

FP840



OBERFL KOMPA-FP840

FP841



OBERFL KOMPA-FP841

FP842



OBERFL KOMPA-FP842

# PARTsolutions

1



OBERFL

1.5



KOMPA

FP950



OBERFL KOMPA-FP950

FP951



OBERFL KOMPA-FP951

FP952



OBERFL KOMPA-FP952

FV99



OBERFL KOMPA-FV99

K-ROLLEN



OBERFL KOMPA-K-ROLLEN

K120-60

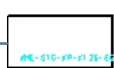

OBERFL KOMPA-K120-60

K120-80



OBERFL KOMPA-K120-80

K140-70

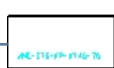

OBERFL KOMPA-K140-70

# PARTsolutions

1



OBERFL

1.5



KOMPA

**K160-80**

OBERFL KOMPA-K160-80



**K180-90**

OBERFL KOMPA-K180-90



**K80-80**

OBERFL KOMPA-K80-80

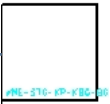

**LZ10DA**

OBERFL KOMPA-LZ10DA

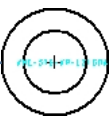

**P120-80**

OBERFL KOMPA-P120-80



**P140-70**

OBERFL KOMPA-P140-70



**P160-80**

OBERFL KOMPA-P160-80



**P80-80**

OBERFL KOMPA-P80-80



# PARTsolutions

1

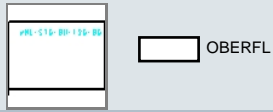

OBERFL

1.5

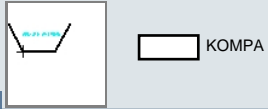

KOMPA

PRU-080



OBERFL KOMPA-PRU-080

PRU-100



OBERFL KOMPA-PRU-100

PRU-120



OBERFL KOMPA-PRU-120

PTR-140



OBERFL KOMPA-PTR-140

PTR-160

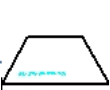

OBERFL KOMPA-PTR-160

RB111



OBERFL KOMPA-RB111

RB112



OBERFL KOMPA-RB112

RB131



OBERFL KOMPA-RB131

1



OBERFL

1.5



KOMPA

RB132



OBERFL KOMPA-RB132

RB161



OBERFL KOMPA-RB161

RB162



OBERFL KOMPA-RB162

RB351



OBERFL KOMPA-RB351

RB352



OBERFL KOMPA-RB352

RB361



OBERFL KOMPA-RB361

RB362



OBERFL KOMPA-RB362

RU-10-54



OBERFL KOMPA-RU-10-54



# PARTsolutions

1



OBERFL

1.5



KOMPA

RU-10-74



OBERFL KOMPA-RU-10-74

RU-12-74



OBERFL KOMPA-RU-12-74

RU-80-54



OBERFL KOMPA-RU-80-54

RU-80-74



OBERFL KOMPA-RU-80-74

STPULT-L



OBERFL KOMPA-STPULT-L

STPULT-R

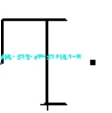

OBERFL KOMPA-STPULT-R

SY-GBREI



OBERFL KOMPA-SY-GBREI

SY-GLAEN



OBERFL KOMPA-SY-GLAEN

# PARTsolutions

1



OBERFL

1.5



KOMPA

SY-HOEHE



OBERFL KOMPA-SY-HOEHE



SY-PBREI



OBERFL KOMPA-SY-PBREI



SY-PDURC



OBERFL KOMPA-SY-PDURC



SY-PLAEN



OBERFL KOMPA-SY-PLAEN



SY-ZWPL



OBERFL KOMPA-SY-ZWPL



TR-140



OBERFL KOMPA-TR-140



TR-160



OBERFL KOMPA-TR-160



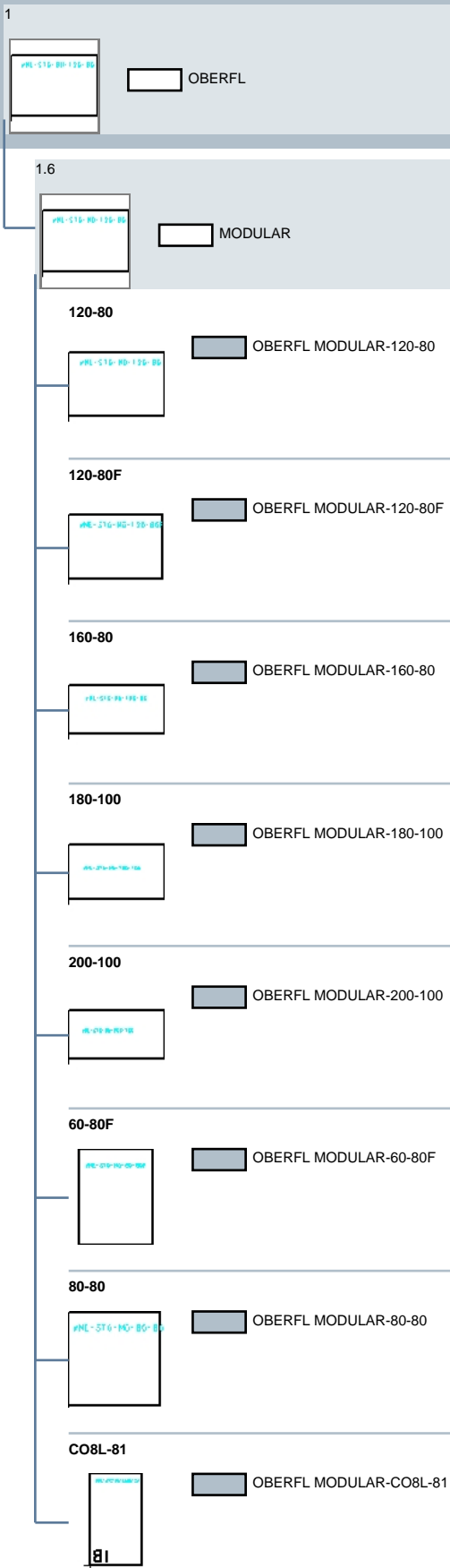

# PARTsolutions

1

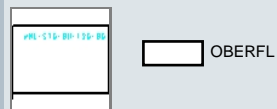

1.6

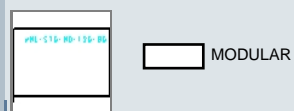

CO8L-82



OBERFL MODULAR-CO8L-82

CO8L-83



OBERFL MODULAR-CO8L-83

CO8R-81



OBERFL MODULAR-CO8R-81

CO8R-82



OBERFL MODULAR-CO8R-82

CO8R-83



OBERFL MODULAR-CO8R-83

CPU



OBERFL MODULAR-CPU

ENDFL



OBERFL MODULAR-ENDFL

ENDFR



OBERFL MODULAR-ENDFR

# PARTsolutions

1

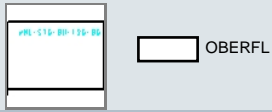

1.6

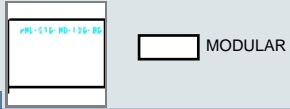

KK

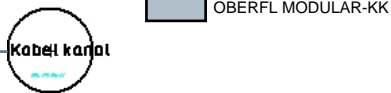

KURZFL

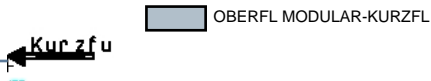

KURZFR

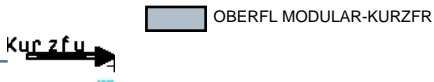

KW



MF291

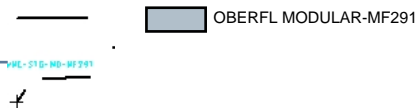

MF292

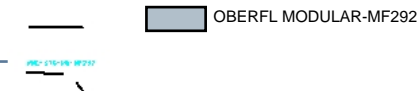

MH22

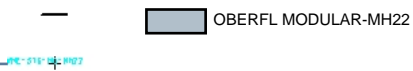

MH33

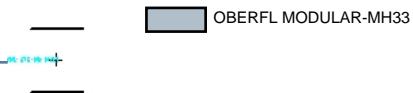

# PARTsolutions

1

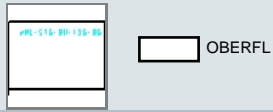

1.6



**MK121**

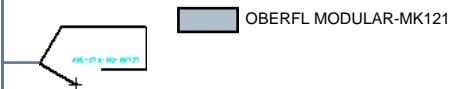

**MK122**

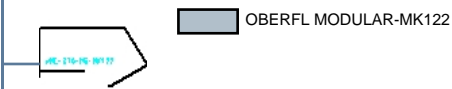

**MK131**

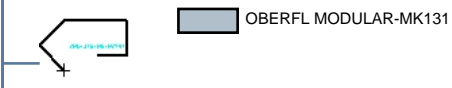

**MK132**



**MK161**

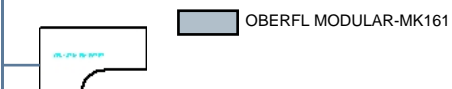

**MK162**



**MK180**



**MK181**

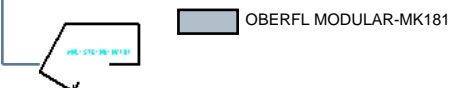

# PARTsolutions

1

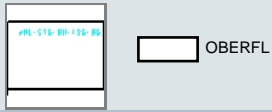

1.6



**MK182**



**MK251**

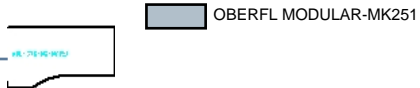

**MK252**

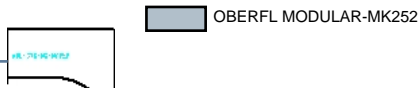

**MK261**

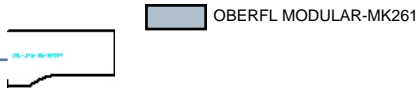

**MK262**

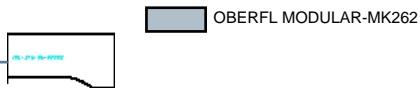

**MK351**

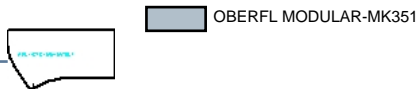

**MK352**

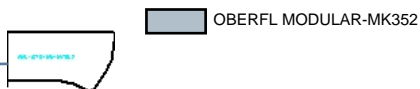

**MK361**

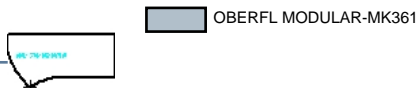

1

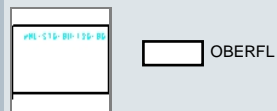

1.6



MK362

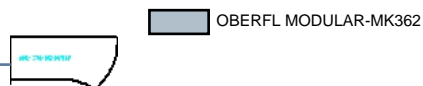

MONT

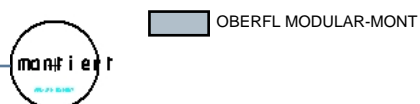

NQ6K7

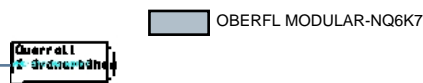

NQ6L7

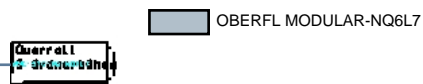

PE115

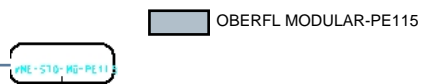

PE123

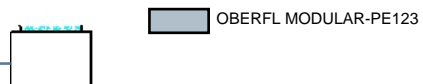

PE124

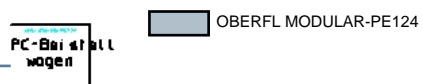

PL72

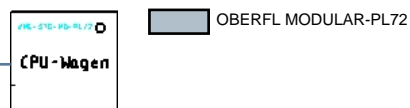



# PARTsolutions

1

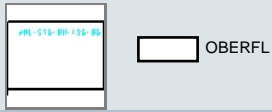

1.6



PL80



OBERFL MODULAR-PL80

PL82



OBERFL MODULAR-PL82

PV18



OBERFL MODULAR-PV18

PZ80



OBERFL MODULAR-PZ80

PZ81



OBERFL MODULAR-PZ81

RWB-120

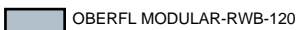

OBERFL MODULAR-RWB-120

RWB-120F



OBERFL MODULAR-RWB-120F

RWB-140



OBERFL MODULAR-RWB-140

# PARTsolutions

1



OBERFL

1.6



MODULAR

RWB-160

OBERFL MODULAR-RWB-160

RWB-180

OBERFL MODULAR-RWB-180

RWB-200

OBERFL MODULAR-RWB-200

RWB-60F

OBERFL MODULAR-RWB-60F

RWB-80

OBERFL MODULAR-RWB-80

ST8L-81

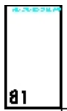

OBERFL MODULAR-ST8L-81

ST8L-82

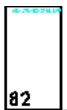

OBERFL MODULAR-ST8L-82

ST8L-83



OBERFL MODULAR-ST8L-83

1

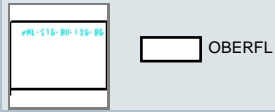

1.6



ST8L-84

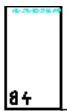

OBERFL MODULAR-ST8L-84

ST8R-81

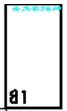

OBERFL MODULAR-ST8R-81

ST8R-82

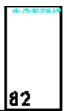

OBERFL MODULAR-ST8R-82

ST8R-83

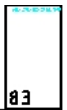

OBERFL MODULAR-ST8R-83

ST8R-84

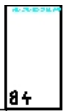

OBERFL MODULAR-ST8R-84

STEHPL



OBERFL MODULAR-STEHPL

STEHPR

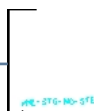

OBERFL MODULAR-STEHPR

STFUSS



OBERFL MODULAR-STFUSS

# PARTsolutions

1

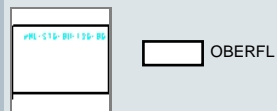

1.6



SZ20



SZ22



V-270



V-4X80D

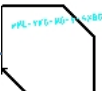

V-90ECK



V-FLUL

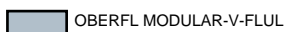

V-FLUR



V-HK



1

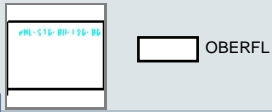

1.6

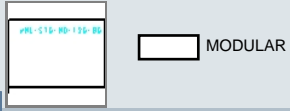

### V-TROPF

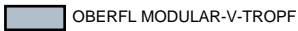

WHL-W90-MQ-V-1PDR

### VS-KONF



WHL-W90-MQ-VS-KONF

### VS-STERN



WHL-W90-MQ-VS-KONF

### W90B



WHL-W90-MQ-W90B

1.7

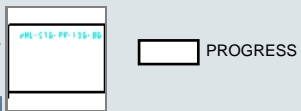

### 120-80



WHL-W90-MQ-W90B

### 120-80F



WHL-W90-MQ-W90B

### 160-80



WHL-W90-MQ-W90B

# PARTsolutions

1

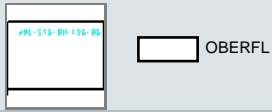

1.7

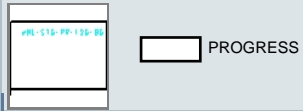

180-100

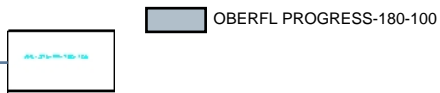

200-100

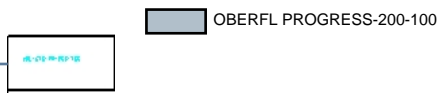

60-80F

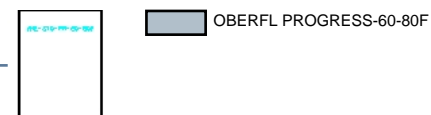

80-80



CO8L-81

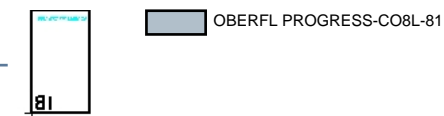

CO8L-82

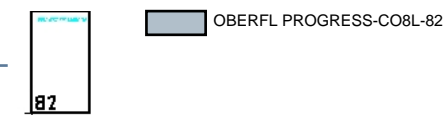

CO8L-83

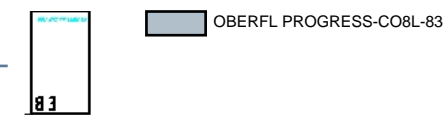

CO8R-81

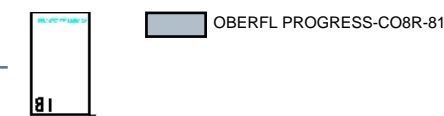

# PARTsolutions

1

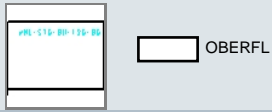

1.7

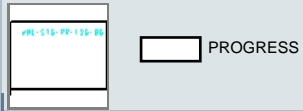

CO8R-82

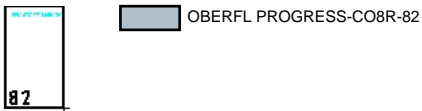

CO8R-83

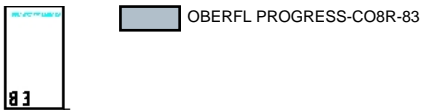

CPU

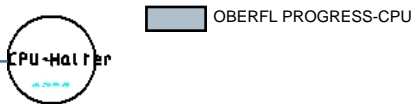

ENDFL

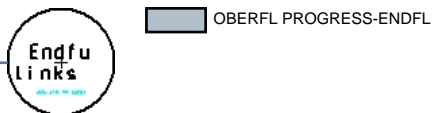

ENDFR

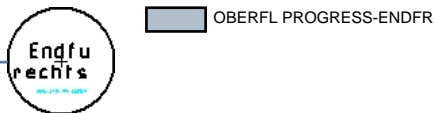

KK

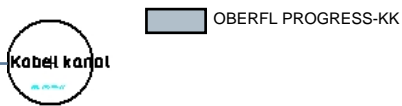

KURZFL

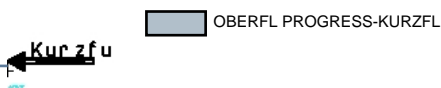

KURZFR

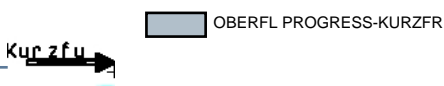

1

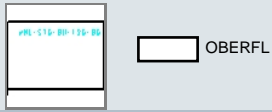

1.7

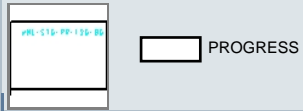

KW



MONT

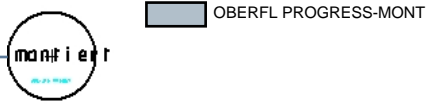

NQ6K7

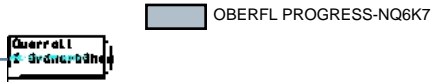

NQ6L7

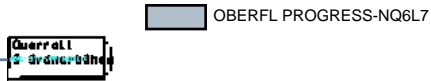

PE115

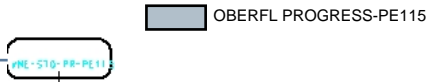

PE123

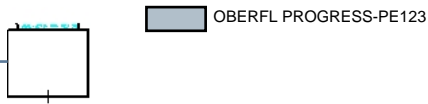

PE124

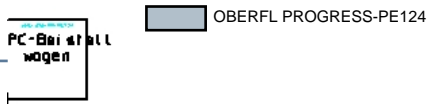

PF291

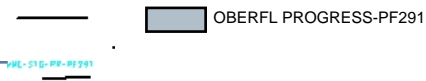

≠



# PARTsolutions

1



1.7

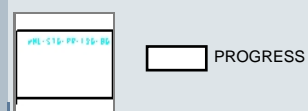

PF292

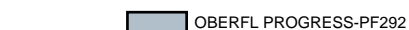

MEX-210-PP-1120-00

PH22

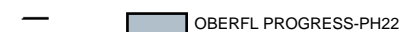

MEX-210-PP-1120-00

PH33

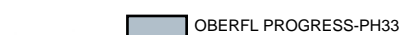

MEX-210-PP-1120-00

PK121

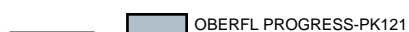

MEX-210-PP-1120-00

PK122

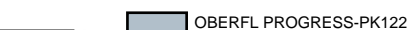

MEX-210-PP-1120-00

PK131

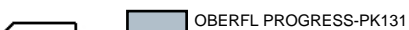

MEX-210-PP-1120-00

PK132

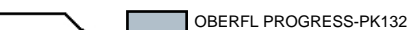

MEX-210-PP-1120-00

PK161

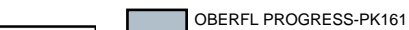

MEX-210-PP-1120-00

1

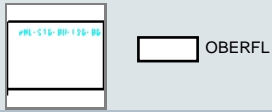

1.7

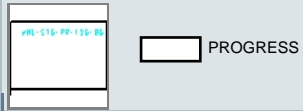

**PK162**



OBERFL PROGRESS-PK162

**PK180**



OBERFL PROGRESS-PK180

**PK181**



OBERFL PROGRESS-PK181

**PK182**



OBERFL PROGRESS-PK182

**PK251**



OBERFL PROGRESS-PK251

**PK252**



OBERFL PROGRESS-PK252

**PK261**



OBERFL PROGRESS-PK261

**PK262**



OBERFL PROGRESS-PK262

1

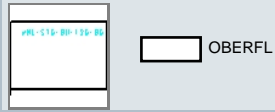

1.7

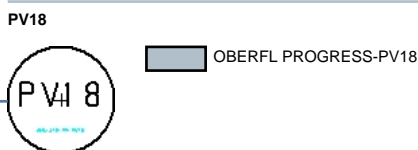
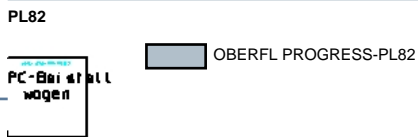
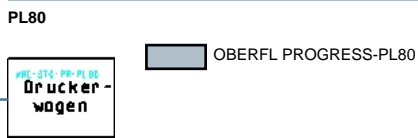
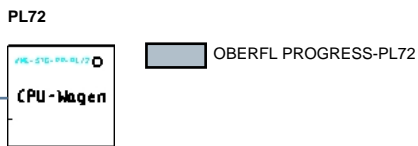
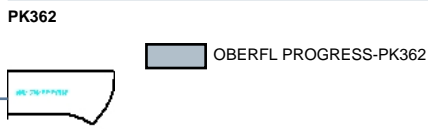
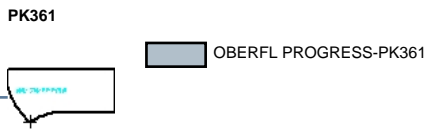
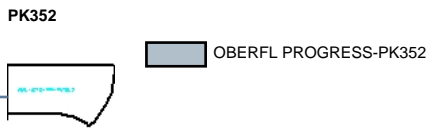
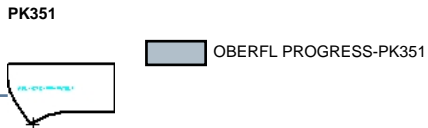
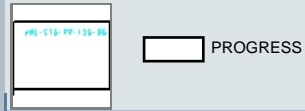

# PARTsolutions

1

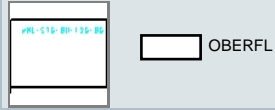

1.7

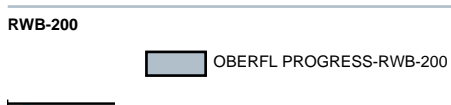
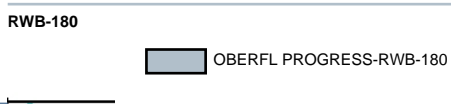
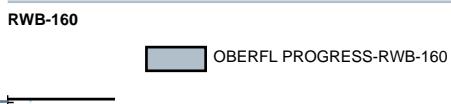
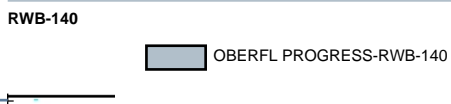
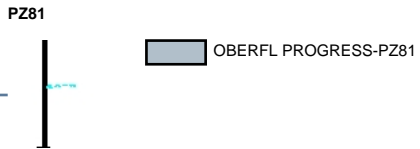
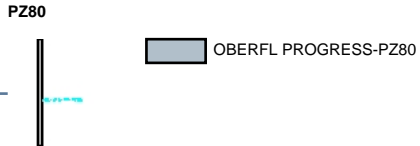

# PARTsolutions

1



OBERFL

1.7



PROGRESS

RWB-60F

OBERFL PROGRESS-RWB-60F

RWB-80

OBERFL PROGRESS-RWB-80

ST8L-81



OBERFL PROGRESS-ST8L-81

ST8L-82

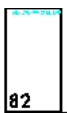

OBERFL PROGRESS-ST8L-82

ST8L-83

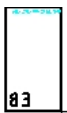

OBERFL PROGRESS-ST8L-83

ST8L-84

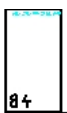

OBERFL PROGRESS-ST8L-84

ST8R-81

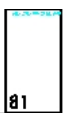

OBERFL PROGRESS-ST8R-81

ST8R-82

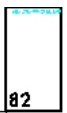

OBERFL PROGRESS-ST8R-82

1

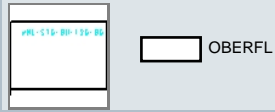

1.7

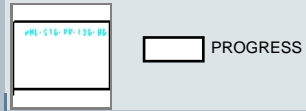

ST8R-83



OBERFL PROGRESS-ST8R-83

ST8R-84



OBERFL PROGRESS-ST8R-84

STEHPL



OBERFL PROGRESS-STEHP

STEHPR

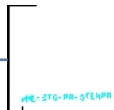

OBERFL PROGRESS-STEHP

STFUSS



OBERFL PROGRESS-STFUSS

SZ20



OBERFL PROGRESS-SZ20

SZ22



OBERFL PROGRESS-SZ22

V-270



OBERFL PROGRESS-V-270

1

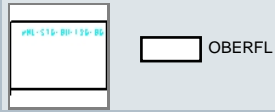

1.7

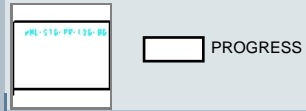

V-4X80D

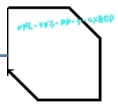

OBERFL PROGRESS-V-4X80D

V-90ECK



OBERFL PROGRESS-V-90ECK

V-FLUL

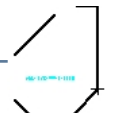

OBERFL PROGRESS-V-FLUL

V-FLUR



OBERFL PROGRESS-V-FLUR

V-HK



OBERFL PROGRESS-V-HK

V-TROPF



OBERFL PROGRESS-V-TROPF

VS-KONF



OBERFL PROGRESS-VS-KONF

VS-STERN



OBERFL PROGRESS-VS-STERN

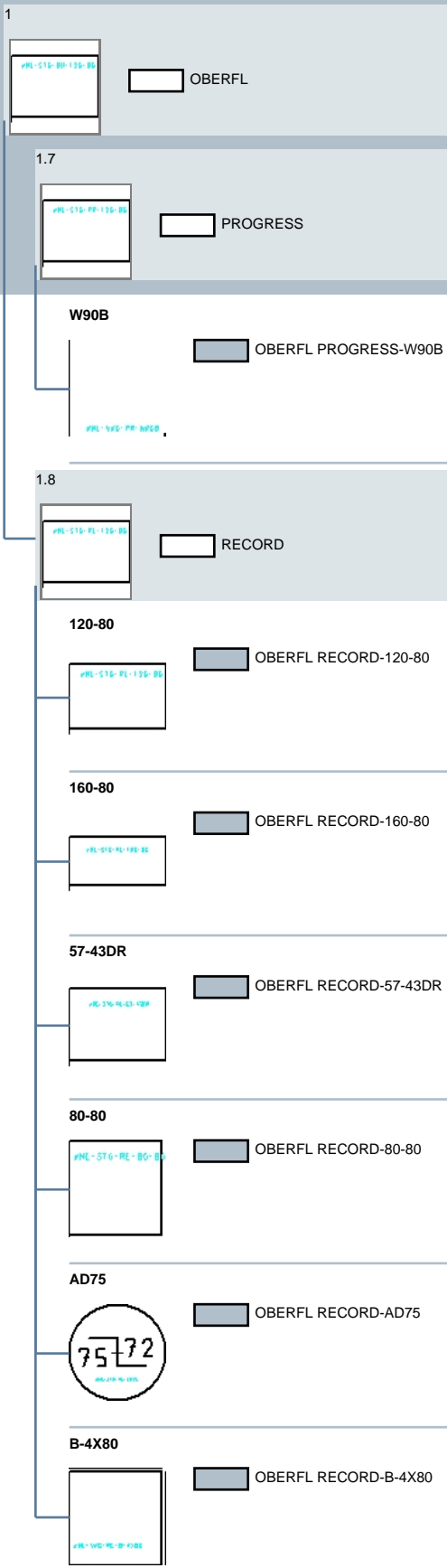



# PARTsolutions

1

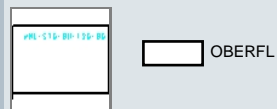

1.8



**B-4X80D**

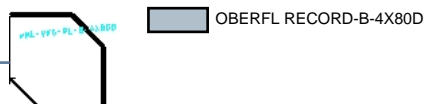

**B-90ECK**

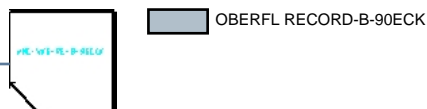

**B45**

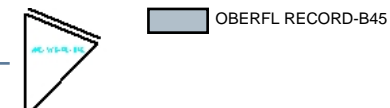

**B45B**

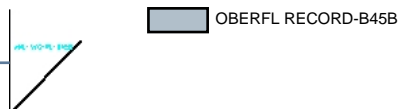

**B90**

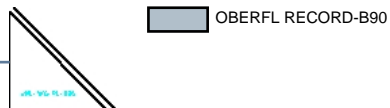

**B90B**

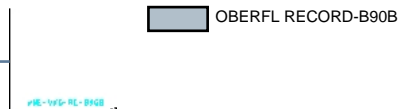

**BS-STERN**

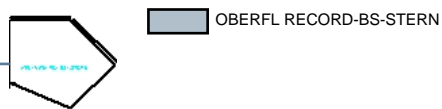

**CO6L-62**

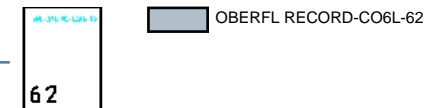

# PARTsolutions

1

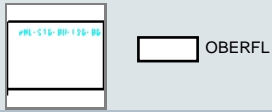

1.8



CO6L-63



CO6L-67



CO6L-68



CO6R-62



CO6R-63



CO6R-67



CO6R-68



F-4X80



# PARTsolutions

1

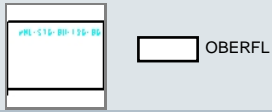

1.8



**F-4X80D**

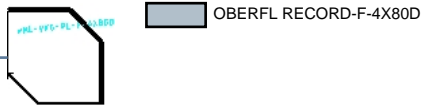

**F-90ECK**



**F45**



**F45B**

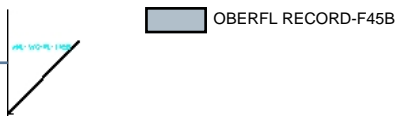

**F90**

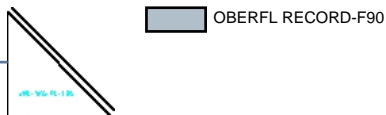

**F90B**

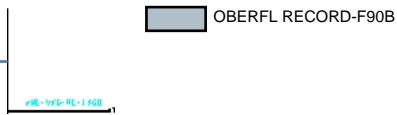

**FS-STERN**

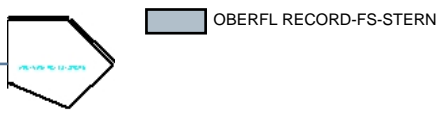

**KURZF**

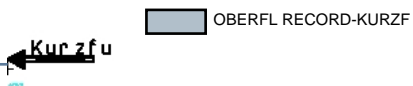

# PARTsolutions

1



OBERFL

1.8



RECORD

**MONT**



OBERFL RECORD-MONT

**SAULENFU**

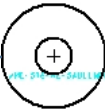

OBERFL RECORD-SAULENFU

**ST8L-81**

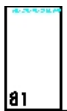

OBERFL RECORD-ST8L-81

**ST8L-82**



OBERFL RECORD-ST8L-82

**ST8L-83**



OBERFL RECORD-ST8L-83

**ST8L-84**



OBERFL RECORD-ST8L-84

**ST8R-81**



OBERFL RECORD-ST8R-81

**ST8R-82**



OBERFL RECORD-ST8R-82

# PARTsolutions

1

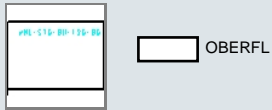

OBERFL

1.8



RECORD

ST8R-83



OBERFL RECORD-ST8R-83

ST8R-84



OBERFL RECORD-ST8R-84

STFUSS



OBERFL RECORD-STFUSS

SY-BLEND



OBERFL RECORD-SY-BLEND

SY-DIAG



OBERFL RECORD-SY-DIAG

SY-VB75



OBERFL RECORD-SY-VB75

V-270



OBERFL RECORD-V-270

V-4X80



OBERFL RECORD-V-4X80

# PARTsolutions

1

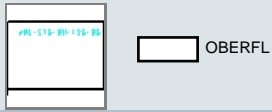

1.8



**V-4X80D**

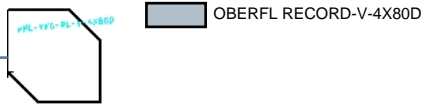

**V-90ECK**

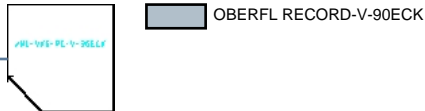

**V-BOG**



**V-BOG120**

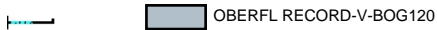

**V-FLUL**

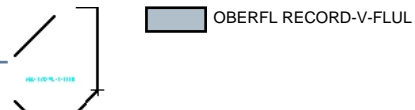

**V-FLUR**

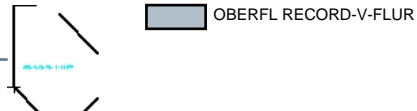

**V-HK**

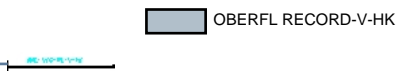

**V-TROPF**



# PARTsolutions

1

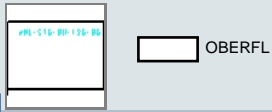

1.8



**VS-KONF**

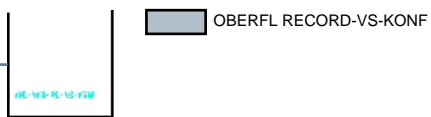

**VS-STERN**

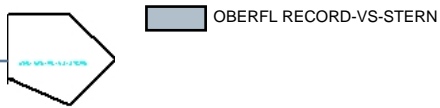

**W45**

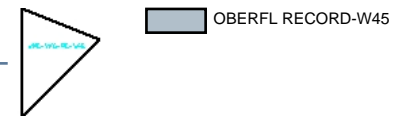

**W45B**

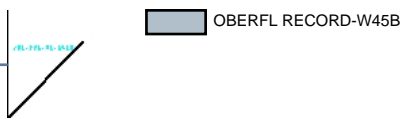

**W90**

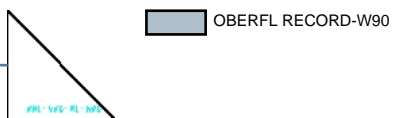

**W90B**

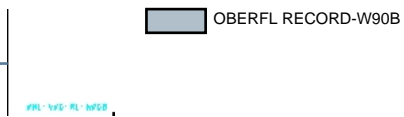

1.9



# PARTsolutions

1

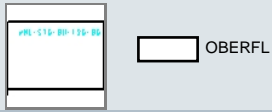

1.9



160-80



80-80



A-80-20

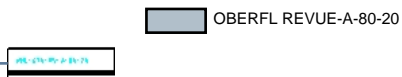

A120-20

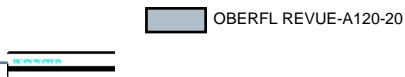

A160-20

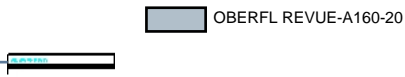

A200-20

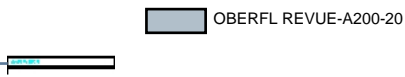

AD75

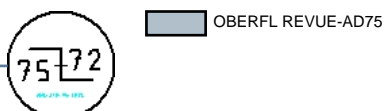

B-4X80

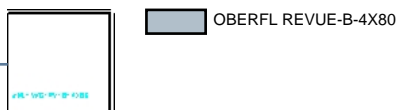



# PARTsolutions

1

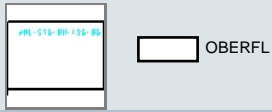

OBERFL

1.9



REVUE

**B-4X80D**



OBERFL REVUE-B-4X80D

**B-90ECK**



OBERFL REVUE-B-90ECK

**B45**

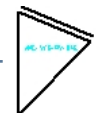

OBERFL REVUE-B45

**B45B**



OBERFL REVUE-B45B

**B90**



OBERFL REVUE-B90

**B90B**

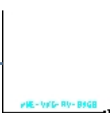

OBERFL REVUE-B90B

**BS-STERN**



OBERFL REVUE-BS-STERN

**CO6L-62**

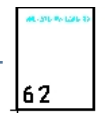

OBERFL REVUE-CO6L-62

62

# PARTsolutions

1

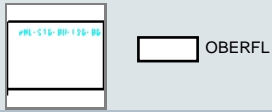

1.9



CO6L-63



OBERFL REVUE-CO6L-63

CO6L-67



OBERFL REVUE-CO6L-67

CO6L-68



OBERFL REVUE-CO6L-68

CO6R-62



OBERFL REVUE-CO6R-62

CO6R-63



OBERFL REVUE-CO6R-63

CO6R-67



OBERFL REVUE-CO6R-67

CO6R-68



OBERFL REVUE-CO6R-68

F-4X80



OBERFL REVUE-F-4X80

# PARTsolutions

1

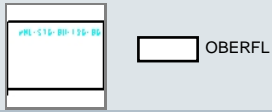

1.9



F-4X80D

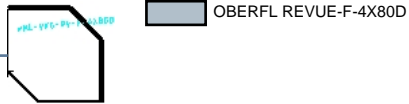

F-90ECK

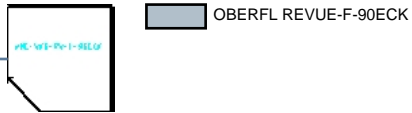

F45



F45B

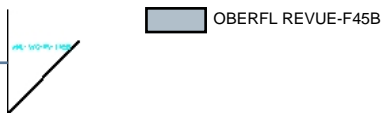

F90

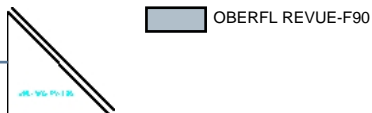

F90B

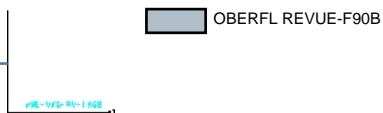

FS-STERN

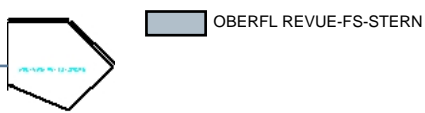

KURZF

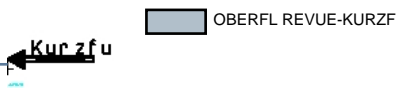

# PARTsolutions

1



OBERFL

1.9



REVUE

**MONT-UBL**

OBERFL REVUE-MONT-UBL



**MONT-UBR**

OBERFL REVUE-MONT-UBR



**MONT**

OBERFL REVUE-MONT



**RK111**

OBERFL REVUE-RK111



**RK112**

OBERFL REVUE-RK112



**RK141**

OBERFL REVUE-RK141



**RK142**

OBERFL REVUE-RK142



**RK351**

OBERFL REVUE-RK351



# PARTsolutions

1



OBERFL

1.9



REVUE

RK352



OBERFL REVUE-RK352

RK361



OBERFL REVUE-RK361

RK362



OBERFL REVUE-RK362

SAULENFU

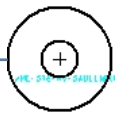

OBERFL REVUE-SAULENFU

ST8L-81

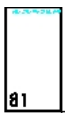

OBERFL REVUE-ST8L-81

ST8L-82

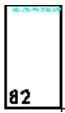

OBERFL REVUE-ST8L-82

ST8L-83

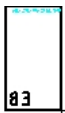

OBERFL REVUE-ST8L-83

ST8L-84

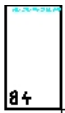

OBERFL REVUE-ST8L-84

1

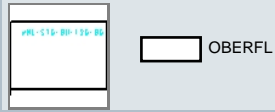

OBERFL

1.9



REVUE

ST8R-81



OBERFL REVUE-ST8R-81

ST8R-82



OBERFL REVUE-ST8R-82

ST8R-83



OBERFL REVUE-ST8R-83

ST8R-84



OBERFL REVUE-ST8R-84

STFUSS



OBERFL REVUE-STFUSS

SY-BLEND



OBERFL REVUE-SY-BLEND

SY-DIAG



OBERFL REVUE-SY-DIAG

SY-VB75



OBERFL REVUE-SY-VB75

# PARTsolutions

1

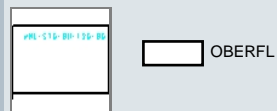

1.9



TA-120

OBERFL REVUE-TA-120



TA-160

OBERFL REVUE-TA-160



TA-80

OBERFL REVUE-TA-80



TA-W45

OBERFL REVUE-TA-W45



TA-W45L

OBERFL REVUE-TA-W45L



TA-W45R

OBERFL REVUE-TA-W45R



TA-W90

OBERFL REVUE-TA-W90



TA-W90L

OBERFL REVUE-TA-W90L



# PARTsolutions

1



OBERFL

1.9



REVUE

TA-W90R

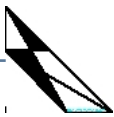

OBERFL REVUE-TA-W90R

UB6L-61

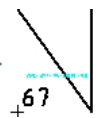

OBERFL REVUE-UB6L-61

UB6L-61A

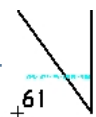

OBERFL REVUE-UB6L-61A

UB6L-62



OBERFL REVUE-UB6L-62

UB6L-62A

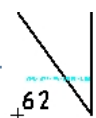

OBERFL REVUE-UB6L-62A

UB6L-63



OBERFL REVUE-UB6L-63

UB6L-63A

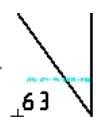

OBERFL REVUE-UB6L-63A

UB6R-61

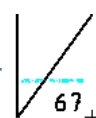

OBERFL REVUE-UB6R-61



1

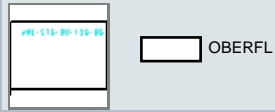

1.9



UB6R-61A

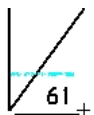

OBERFL REVUE-UB6R-61A

UB6R-62

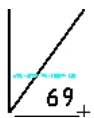

OBERFL REVUE-UB6R-62

UB6R-62A

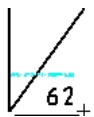

OBERFL REVUE-UB6R-62A

UB6R-63

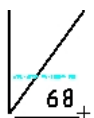

OBERFL REVUE-UB6R-63

UB6R-63A

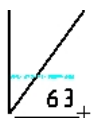

OBERFL REVUE-UB6R-63A

V-270



OBERFL REVUE-V-270

V-4X80



OBERFL REVUE-V-4X80

V-4X80D



OBERFL REVUE-V-4X80D

# PARTsolutions

1

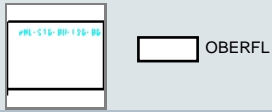

1.9

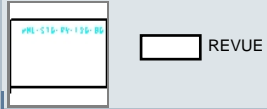

**V-90ECK**

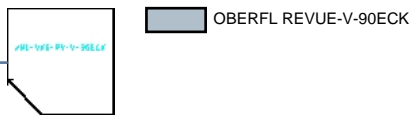

**V-BOG**



**V-BOG120**



**V-FLUL**

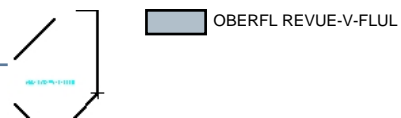

**V-FLUR**

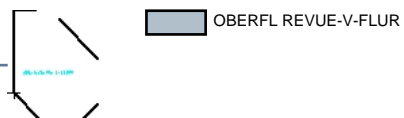

**V-HK**

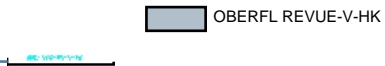

**V-TROPF**

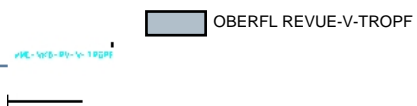

**VS-KONF**

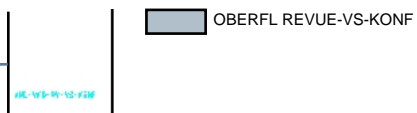

# PARTsolutions

1

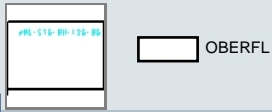

1.9



**VS-STERN**

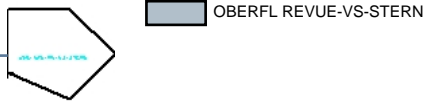

**W45**



**W45B**



**W90**

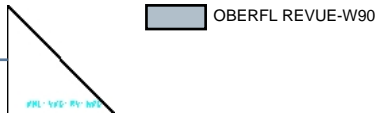

**W90B**

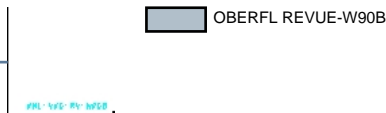

1.10



**120-80**

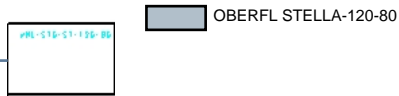

**120-80K**

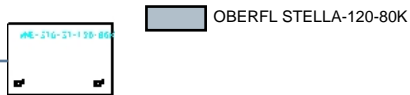

1

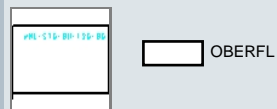

1.10



120-80L

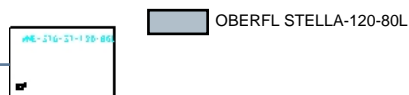

120-80R

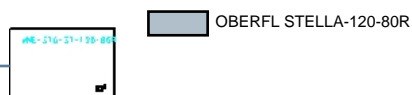

160-80

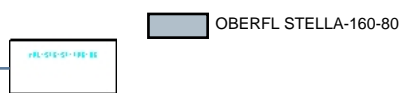

160-80K

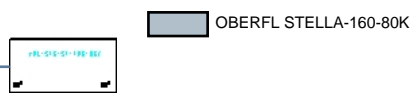

160-80L

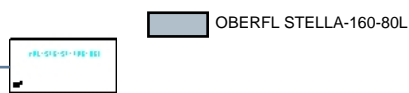

160-80R

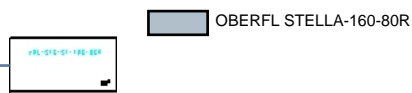

57-43DR

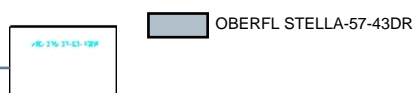

80-80

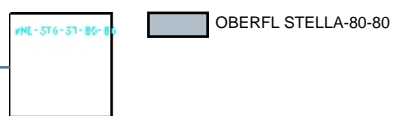

1

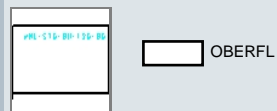

1.10



80-80K

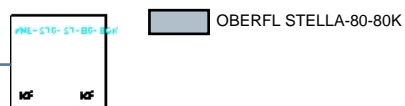

80-80L

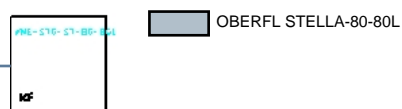

80-80R

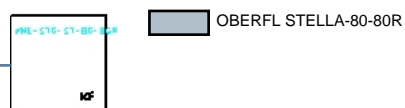

A-80-20

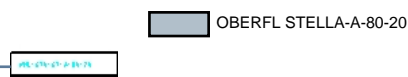

A120-20

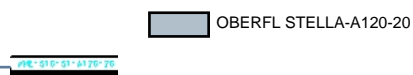

A160-20

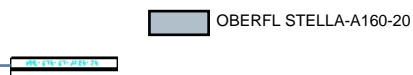

AD75

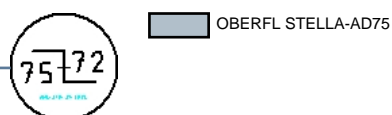

B-4X80

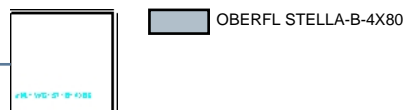

# PARTsolutions

1

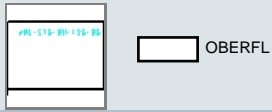

1.10



**B-4X80D**



**B-90ECK**

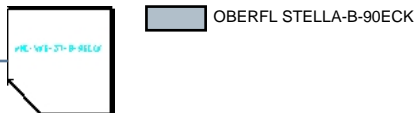

**B45**



**B45B**

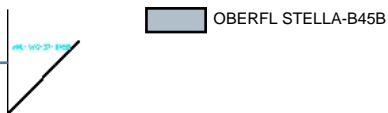

**B90**

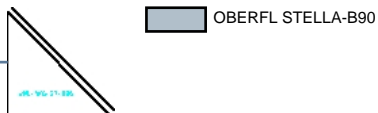

**B90B**

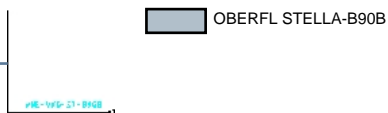

**BS-STERN**

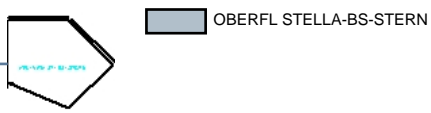

**CO8L-81**

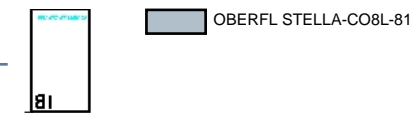

81

1

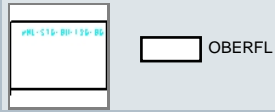

1.10



CO8L-82



OBERFL STELLA-CO8L-82

CO8L-83



OBERFL STELLA-CO8L-83

CO8R-81



OBERFL STELLA-CO8R-81

CO8R-82



OBERFL STELLA-CO8R-82

CO8R-83



OBERFL STELLA-CO8R-83

LV14



OBERFL STELLA-LV14

PLHALT



OBERFL STELLA-PLHALT

SAULENFU

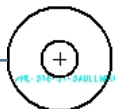

OBERFL STELLA-SAULENFU

# PARTsolutions

1

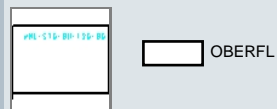

1.10



ST8L-81

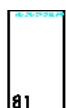

OBERFL STELLA-ST8L-81

ST8L-82



OBERFL STELLA-ST8L-82

ST8L-83

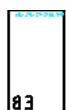

OBERFL STELLA-ST8L-83

ST8L-84

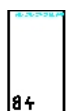

OBERFL STELLA-ST8L-84

ST8R-81

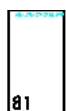

OBERFL STELLA-ST8R-81

ST8R-82



OBERFL STELLA-ST8R-82

ST8R-83



OBERFL STELLA-ST8R-83

ST8R-84

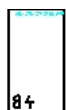

OBERFL STELLA-ST8R-84



# PARTsolutions

1

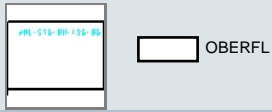

1.10

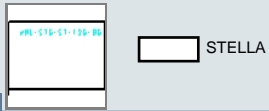

**STFUSS**

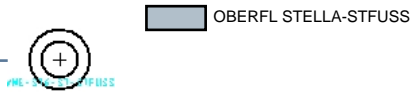

**SY-DIAG**

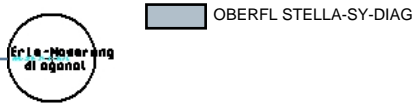

**SY-VB75**

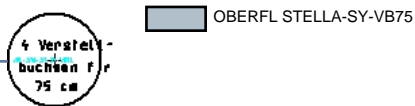

**TA-120**

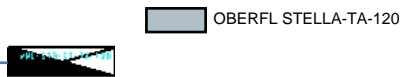

**TA-160**

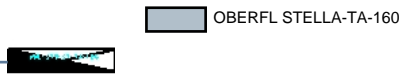

**TA-80**

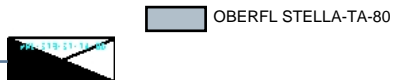

**TA-W45**

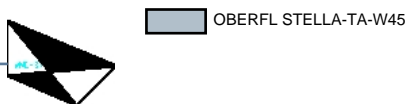

**TA-W45L**

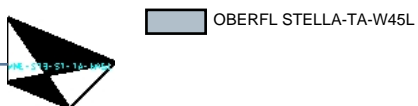

# PARTsolutions

1



OBERFL

1.10



STELLA

TA-W45R



OBERFL STELLA-TA-W45R

TA-W90



OBERFL STELLA-TA-W90

TA-W90L

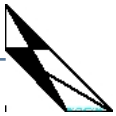

OBERFL STELLA-TA-W90L

TA-W90R

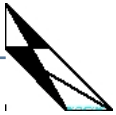

OBERFL STELLA-TA-W90R

V-4X80



OBERFL STELLA-V-4X80

V-4X80D

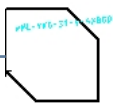

OBERFL STELLA-V-4X80D

V-90ECK



OBERFL STELLA-V-90ECK

V-BOG



OBERFL STELLA-V-BOG

1

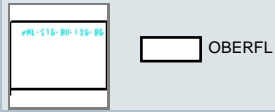

1.10



V-BOG120



V-FLUL

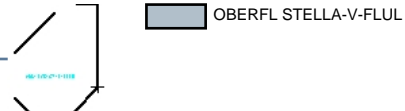

V-FLUR



V-HK

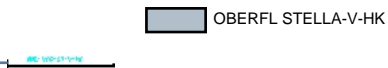

V-TROPF

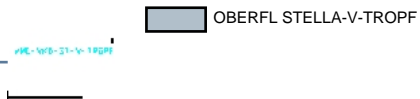

VS-KONF

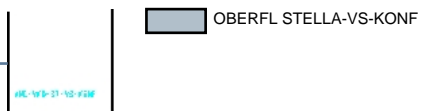

VS-STERN

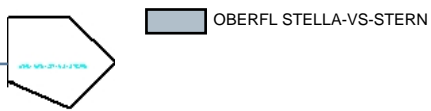

W45

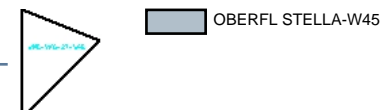

1

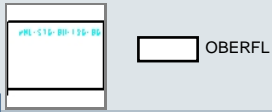

1.10

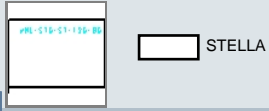

W45B

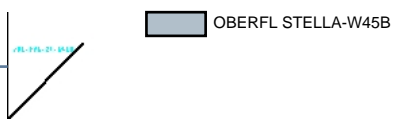

W90

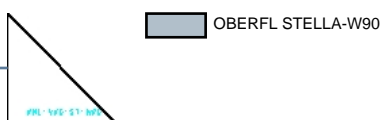

W90B

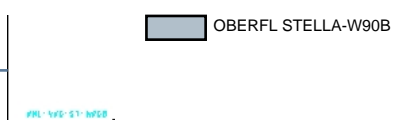

1.11

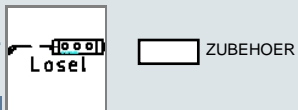

3DOSE-LO

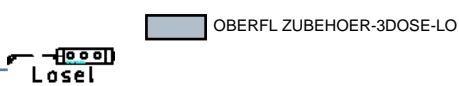

3DOSE-PL

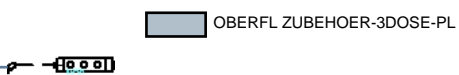

CO-GGW

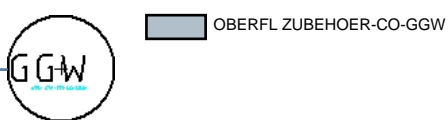

CO-ROLL

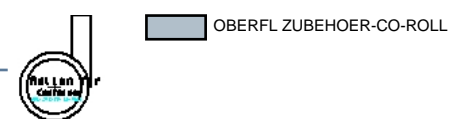

# PARTsolutions

1

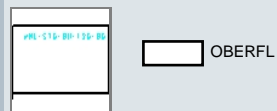

1.11

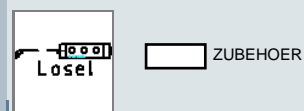

ERSCH-ZV

OBERFL ZUBEHOER-ERSCH-ZV



FN15

OBERFL ZUBEHOER-FN15



FN16

OBERFL ZUBEHOER-FN16



FN17

OBERFL ZUBEHOER-FN17



KABDU-LO

OBERFL ZUBEHOER-KABDU-LO



KABEHALT

OBERFL ZUBEHOER-KABEHALT



KABEL-03

OBERFL ZUBEHOER-KABEL-03



KABEL-05

OBERFL ZUBEHOER-KABEL-05



1



OBERFL

1.11



ZUBEHOER

KABEL-10

OBERFL ZUBEHOER-KABEL-10



KABEL-20

OBERFL ZUBEHOER-KABEL-20



KABELDU

OBERFL ZUBEHOER-KABELDU

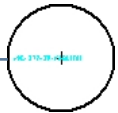

KABFUEH

OBERFL ZUBEHOER-KABFUEH



PN28

OBERFL ZUBEHOER-PN28

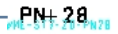

PN29

OBERFL ZUBEHOER-PN29

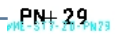

SCHALT

OBERFL ZUBEHOER-SCHALT



SY-100P

OBERFL ZUBEHOER-SY-100P



1



1.11

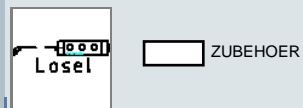

SY-10P

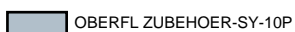

Aufschlag 10

SY-150P

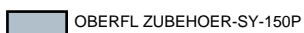

Aufschlag 150

SY-15P

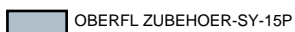

Aufschlag 15

SY-20P

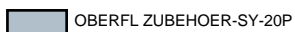

Aufschlag 20

SY-25P

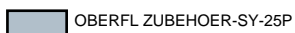

Aufschlag 25

SY-30P



Aufschlag 30

SY-35P



Aufschlag 35

SY-40P

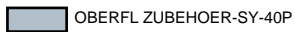

Aufschlag 40

1

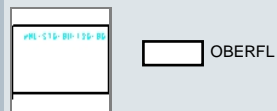

1.11

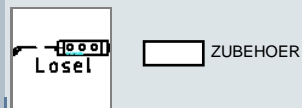

SY-45P



Aufschlag 45

SY-50P

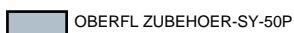

Aufschlag 50

SY-5P

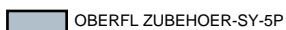

Aufschlag 5

SY-DRUSL



SY-M10P

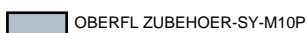

Handlung 10

SY-M15P

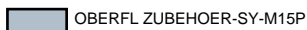

Handlung 15

SY-M20P

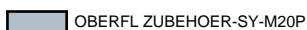

Handlung 20

SY-M25P

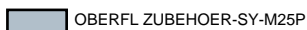

Handlung 25



1



OBERFL

1.11

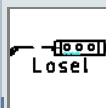

ZUBEHOER

SY-M30P

OBERFL ZUBEHOER-SY-M30P

Wandung 30

SY-M35P

OBERFL ZUBEHOER-SY-M35P

Wandung 35

SY-M40P

OBERFL ZUBEHOER-SY-M40P

Wandung 40

SY-M45P

OBERFL ZUBEHOER-SY-M45P

Wandung 45

SY-M50P

OBERFL ZUBEHOER-SY-M50P

Wandung 50

SY-M5P

OBERFL ZUBEHOER-SY-M5P

Wandung 5

TASTA-AZ

OBERFL ZUBEHOER-TASTA-AZ



ZD20

OBERFL ZUBEHOER-ZD20

Strahlhalter

1



OBERFL

1.11

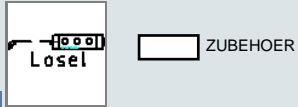

ZUBEHOER

ZD21

OBERFL ZUBEHOER-ZD21

Quantiler

ZD22

OBERFL ZUBEHOER-ZD22

Materialschale

ZD23

OBERFL ZUBEHOER-ZD23

Quantiler

ZD24

OBERFL ZUBEHOER-ZD24

Quantiler AS

ZD25

OBERFL ZUBEHOER-ZD25

Quantiler AS

ZD26

OBERFL ZUBEHOER-ZD26

Schreibblock AS

ZD27

OBERFL ZUBEHOER-ZD27

Steg

ZD28

OBERFL ZUBEHOER-ZD28

Formulareinsatz

1



OBERFL

1.11



ZUBEHOER

ZD29



OBERFL ZUBEHOER-ZD29

Formularer Platz  
für ZD 29

ZD33



OBERFL ZUBEHOER-ZD33

Formularer Platz  
für ZD 33

ZD34



OBERFL ZUBEHOER-ZD34

Formularer Platz  
für ZD 34

2



SCHRANKE

2.1



NORMA

ABR-

+



SCHRANKE NORMA-ABR-

Formularer Platz  
für ABR-

AUR-

+



SCHRANKE NORMA-AUR-

Formularer Platz  
für AUR-

AUSGL100



SCHRANKE NORMA-AUSGL100

Formularer Platz  
für AUSGL100

2

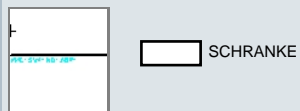

2.1

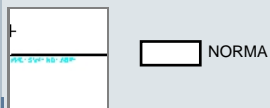

AUSGL140



AUSGL30



AUSGL43



AZUG100

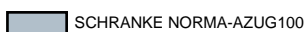

AZUG140



B-C10-O



B-C10-Q



B-C10-QH



2

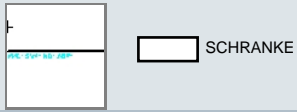

SCHRANKE

2.1

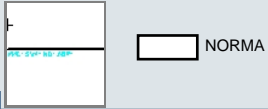

NORMA

**B-C10-TS**



SCHRANKE NORMA-B-C10-TS



**B-C14-O**



SCHRANKE NORMA-B-C14-O



**B-C14-Q**



SCHRANKE NORMA-B-C14-Q



**B-C14-QH**



SCHRANKE NORMA-B-C14-QH



**B-C14-TS**



SCHRANKE NORMA-B-C14-TS



**B-CA-O**



SCHRANKE NORMA-B-CA-O



**B-D10-O**



SCHRANKE NORMA-B-D10-O



**B-D10-Q**



SCHRANKE NORMA-B-D10-Q



2

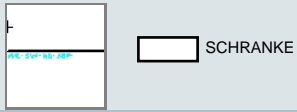

2.1

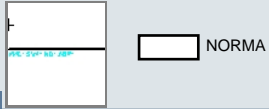

**B-D10-QH**



SCHRANKE NORMA-B-D10-QH



**B-D10-TS**



SCHRANKE NORMA-B-D10-TS



**B-D14-O**



SCHRANKE NORMA-B-D14-O



**B-D14-Q**



SCHRANKE NORMA-B-D14-Q



**B-D14-QH**



SCHRANKE NORMA-B-D14-QH



**B-D14-TS**



SCHRANKE NORMA-B-D14-TS



**B-DA-O**



SCHRANKE NORMA-B-DA-O



**C-ABR**



SCHRANKE NORMA-C-ABR



2

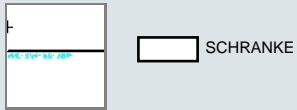

2.1

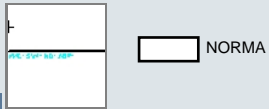

**C10-O**



SCHRANKE NORMA-C10-O

**C10-Q**

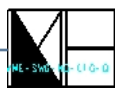

SCHRANKE NORMA-C10-Q

**C10-QH**

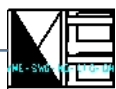

SCHRANKE NORMA-C10-QH

**C10-TS**



SCHRANKE NORMA-C10-TS

**C14-O**



SCHRANKE NORMA-C14-O

**C14-Q**



SCHRANKE NORMA-C14-Q

**C14-QH**



SCHRANKE NORMA-C14-QH

**C14-TS**



SCHRANKE NORMA-C14-TS

2

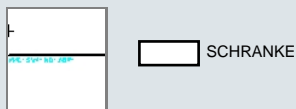

2.1

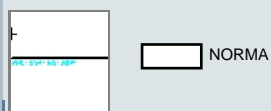

CA-O

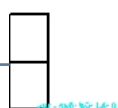

SCHRANKE NORMA-CA-O

D-ABR



SCHRANKE NORMA-D-ABR

D10-O



SCHRANKE NORMA-D10-O

D10-Q



SCHRANKE NORMA-D10-Q

D10-QH



SCHRANKE NORMA-D10-QH

D10-TS



SCHRANKE NORMA-D10-TS

D14-O



SCHRANKE NORMA-D14-O

D14-Q



SCHRANKE NORMA-D14-Q



# PARTsolutions

2

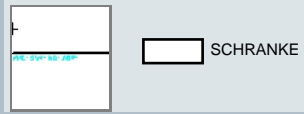

SCHRANKE

2.1

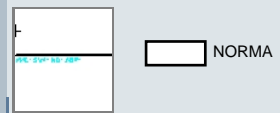

NORMA

D14-QH

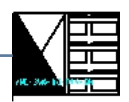

SCHRANKE NORMA-D14-QH

D14-TS



SCHRANKE NORMA-D14-TS

DA-O



SCHRANKE NORMA-DA-O

H100-



SCHRANKE NORMA-H100-

H140-



SCHRANKE NORMA-H140-

HR2



SCHRANKE NORMA-HR2

HR3



SCHRANKE NORMA-HR3

KQ100-

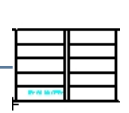

SCHRANKE NORMA-KQ100-

# PARTsolutions

2

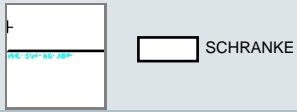

SCHRANKE

2.1

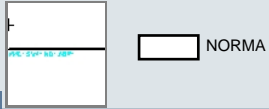

NORMA

KQ140-



SCHRANKE NORMA-KQ140-

KS100-



SCHRANKE NORMA-KS100-

KS140-



SCHRANKE NORMA-KS140-

S-C-ABR



SCHRANKE NORMA-S-C-ABR



S-C10-O



SCHRANKE NORMA-S-C10-O



S-C10-Q



SCHRANKE NORMA-S-C10-Q



S-C10-QH



SCHRANKE NORMA-S-C10-QH



S-C10-TS



SCHRANKE NORMA-S-C10-TS



2

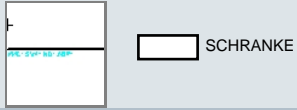

SCHRANKE

2.1

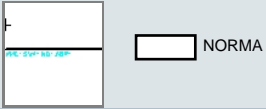

NORMA

S-C14-O



SCHRANKE NORMA-S-C14-O



S-C14-Q



SCHRANKE NORMA-S-C14-Q



S-C14-QH



SCHRANKE NORMA-S-C14-QH



S-C14-TS



SCHRANKE NORMA-S-C14-TS



S-CA-O



SCHRANKE NORMA-S-CA-O



S-D-ABR



SCHRANKE NORMA-S-D-ABR



S-D10-O



SCHRANKE NORMA-S-D10-O



S-D10-Q



SCHRANKE NORMA-S-D10-Q



2

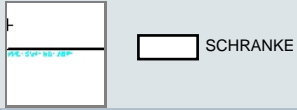

SCHRANKE

2.1

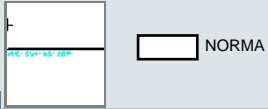

NORMA

### S-D10-QH



SCHRANKE NORMA-S-D10-QH



### S-D10-TS



SCHRANKE NORMA-S-D10-TS



### S-D14-O



SCHRANKE NORMA-S-D14-O



### S-D14-Q



SCHRANKE NORMA-S-D14-Q



### S-D14-QH



SCHRANKE NORMA-S-D14-QH



### S-D14-TS



SCHRANKE NORMA-S-D14-TS



### S-DA-O



SCHRANKE NORMA-S-DA-O



### S100-



SCHRANKE NORMA-S100-

2

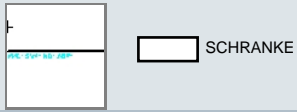

2.1

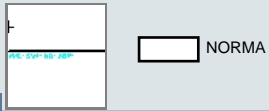

S140-



SRW



V-C-ABR



V-C10-O

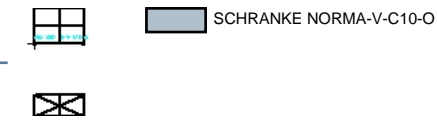

V-C10-Q



V-C10-QH



V-C10-TS

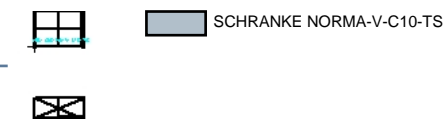

V-C14-O



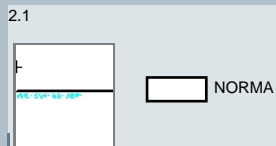
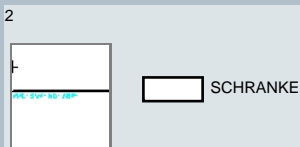

V-C14-Q



SCHRANKE NORMA-V-C14-Q



V-C14-QH



SCHRANKE NORMA-V-C14-QH



V-C14-TS



SCHRANKE NORMA-V-C14-TS



V-CA-O



SCHRANKE NORMA-V-CA-O



V-D-ABR



SCHRANKE NORMA-V-D-ABR



V-D10-O



SCHRANKE NORMA-V-D10-O



V-D10-Q



SCHRANKE NORMA-V-D10-Q



V-D10-QH



SCHRANKE NORMA-V-D10-QH



# PARTsolutions

2

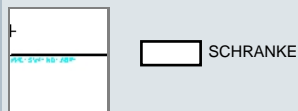

SCHRANKE

2.1

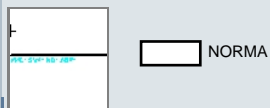

NORMA

V-D10-TS



SCHRANKE NORMA-V-D10-TS



V-D14-O



SCHRANKE NORMA-V-D14-O



V-D14-Q



SCHRANKE NORMA-V-D14-Q



V-D14-QH



SCHRANKE NORMA-V-D14-QH



V-D14-TS



SCHRANKE NORMA-V-D14-TS



V-DA-O



SCHRANKE NORMA-V-DA-O



WBEF



SCHRANKE NORMA-WBEF

X-C-ABR

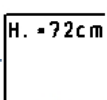

SCHRANKE NORMA-X-C-ABR

2

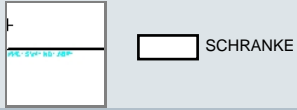

SCHRANKE

2.1

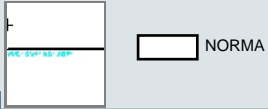

NORMA

X-C10-O

SCHRANKE NORMA-X-C10-O



X-C10-Q

SCHRANKE NORMA-X-C10-Q

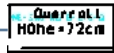

X-C10-QH

SCHRANKE NORMA-X-C10-QH



X-C10-TS

SCHRANKE NORMA-X-C10-TS

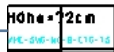

X-C14-O

SCHRANKE NORMA-X-C14-O



X-C14-Q

SCHRANKE NORMA-X-C14-Q



X-C14-QH

SCHRANKE NORMA-X-C14-QH



X-C14-TS

SCHRANKE NORMA-X-C14-TS





2

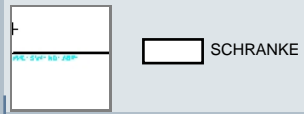

2.1

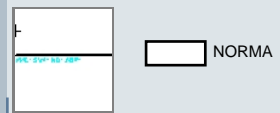

X-CA-O

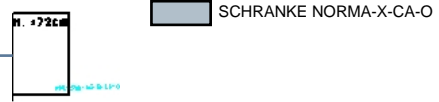

2.2

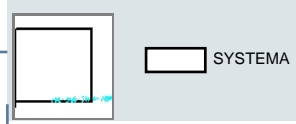

2.2.1

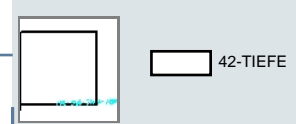

A-ABR

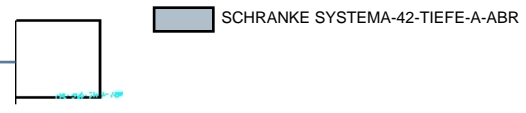

A11-O

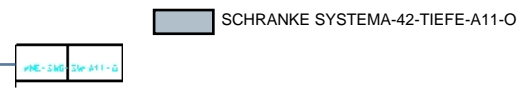

A11-T

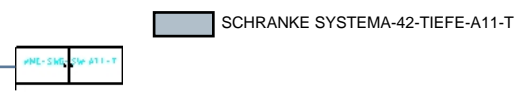

A11-TS

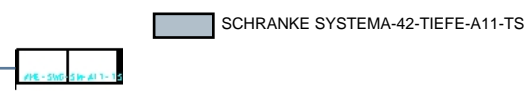

A55-O

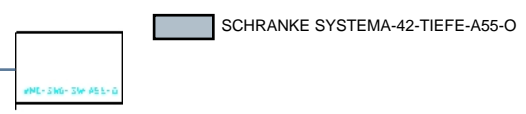

2

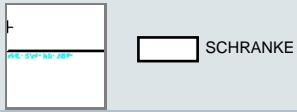

2.2

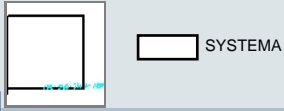

2.2.1

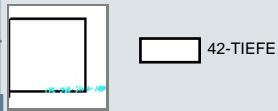

A55-TL



SCHRANKE SYSTEMA-42-TIEFE-A55-TL

A55-TR



SCHRANKE SYSTEMA-42-TIEFE-A55-TR

A80-O



SCHRANKE SYSTEMA-42-TIEFE-A80-O

A80-T



SCHRANKE SYSTEMA-42-TIEFE-A80-T

A80-TS



SCHRANKE SYSTEMA-42-TIEFE-A80-TS

B-ABR

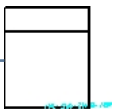

SCHRANKE SYSTEMA-42-TIEFE-B-ABR

B11-O



SCHRANKE SYSTEMA-42-TIEFE-B11-O

# PARTsolutions

2

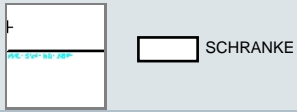

2.2

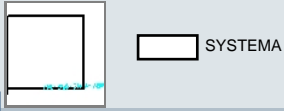

2.2.1

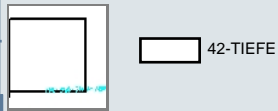

**B11-T**

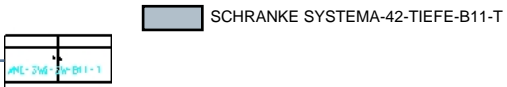

**B11-TS**

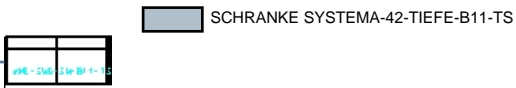

**B55-O**



**B55-TL**

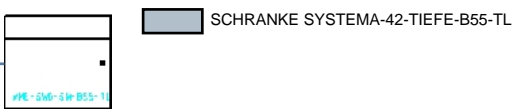

**B55-TR**

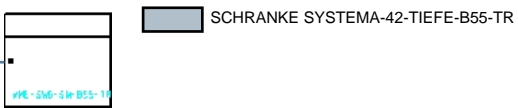

**B80-O**

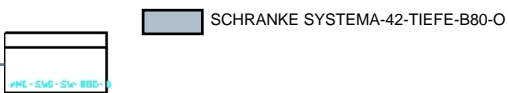

**B80-T**

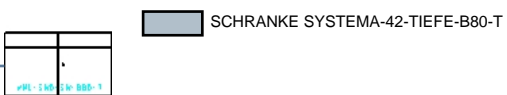

# PARTsolutions

2

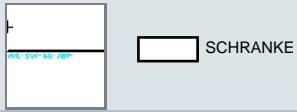

2.2

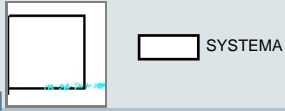

2.2.1

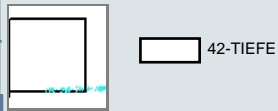

**B80-TS**

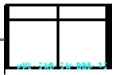

SCHRANKE SYSTEMA-42-TIEFE-B80-TS

**C-ABR**

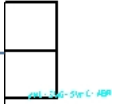

SCHRANKE SYSTEMA-42-TIEFE-C-ABR

**C11-O**



SCHRANKE SYSTEMA-42-TIEFE-C11-O

**C11-T**



SCHRANKE SYSTEMA-42-TIEFE-C11-T

**C11-TS**



SCHRANKE SYSTEMA-42-TIEFE-C11-TS

**C55-O**

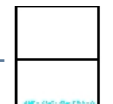

SCHRANKE SYSTEMA-42-TIEFE-C55-O

**C55-TL**



SCHRANKE SYSTEMA-42-TIEFE-C55-TL

2

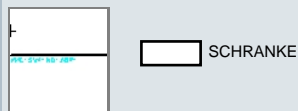

2.2



2.2.1

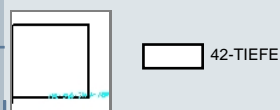

C55-TR

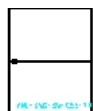

SCHRANKE SYSTEMA-42-TIEFE-C55-TR

C80-O



SCHRANKE SYSTEMA-42-TIEFE-C80-O

C80-T



SCHRANKE SYSTEMA-42-TIEFE-C80-T

C80-TS



SCHRANKE SYSTEMA-42-TIEFE-C80-TS

D-ABR



SCHRANKE SYSTEMA-42-TIEFE-D-ABR

D11-O

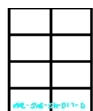

SCHRANKE SYSTEMA-42-TIEFE-D11-O

D11-T

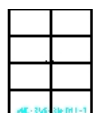

SCHRANKE SYSTEMA-42-TIEFE-D11-T

# PARTsolutions

2

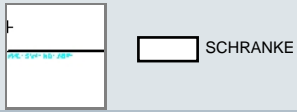

2.2



2.2.1

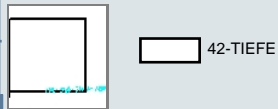

D11-TS

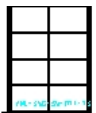

SCHRANKE SYSTEMA-42-TIEFE-D11-TS

D55-O



SCHRANKE SYSTEMA-42-TIEFE-D55-O

D55-TL

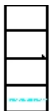

SCHRANKE SYSTEMA-42-TIEFE-D55-TL

D55-TR



SCHRANKE SYSTEMA-42-TIEFE-D55-TR

D80-O



SCHRANKE SYSTEMA-42-TIEFE-D80-O

D80-T

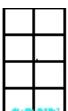

SCHRANKE SYSTEMA-42-TIEFE-D80-T

D80-TS

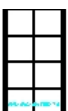

SCHRANKE SYSTEMA-42-TIEFE-D80-TS

2

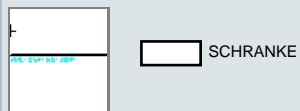

2.2



2.2.1

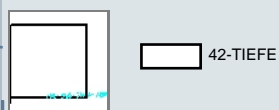

FG211



SCHRANKE SYSTEMA-42-TIEFE-FG211

FG212



SCHRANKE SYSTEMA-42-TIEFE-FG212

FG220



SCHRANKE SYSTEMA-42-TIEFE-FG220

FG230

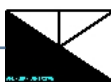

SCHRANKE SYSTEMA-42-TIEFE-FG230

FG311



SCHRANKE SYSTEMA-42-TIEFE-FG311

FG312



SCHRANKE SYSTEMA-42-TIEFE-FG312

FG320



SCHRANKE SYSTEMA-42-TIEFE-FG320

2

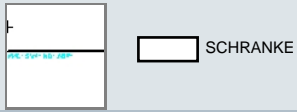

2.2

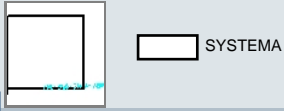

2.2.1

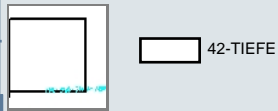

FG330



SCHRANKE SYSTEMA-42-TIEFE-FG330

HA11-O



SCHRANKE SYSTEMA-42-TIEFE-HA11-O

HA11-T



SCHRANKE SYSTEMA-42-TIEFE-HA11-T

HA11-TS



SCHRANKE SYSTEMA-42-TIEFE-HA11-TS

HA55-O



SCHRANKE SYSTEMA-42-TIEFE-HA55-O

HA55-TL



SCHRANKE SYSTEMA-42-TIEFE-HA55-TL

HA55-TR



SCHRANKE SYSTEMA-42-TIEFE-HA55-TR



2

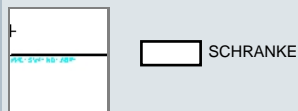

2.2

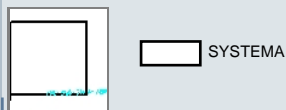

2.2.1

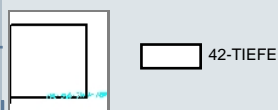

HA80-O

SCHRANKE SYSTEMA-42-TIEFE-HA80-O



HA80-T

SCHRANKE SYSTEMA-42-TIEFE-HA80-T



HA80-TS

SCHRANKE SYSTEMA-42-TIEFE-HA80-TS



HB11-O

SCHRANKE SYSTEMA-42-TIEFE-HB11-O



HB11-T

SCHRANKE SYSTEMA-42-TIEFE-HB11-T



HB11-TS

SCHRANKE SYSTEMA-42-TIEFE-HB11-TS



HB55-O

SCHRANKE SYSTEMA-42-TIEFE-HB55-O

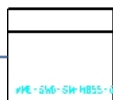

2

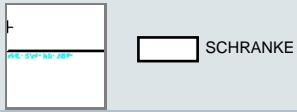

2.2



2.2.1

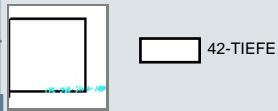

**HB55-TL**



SCHRANKE SYSTEMA-42-TIEFE-HB55-TL

**HB55-TR**



SCHRANKE SYSTEMA-42-TIEFE-HB55-TR

**HB80-O**



SCHRANKE SYSTEMA-42-TIEFE-HB80-O

**HB80-T**



SCHRANKE SYSTEMA-42-TIEFE-HB80-T

**HB80-TS**



SCHRANKE SYSTEMA-42-TIEFE-HB80-TS

**HC11-O**



SCHRANKE SYSTEMA-42-TIEFE-HC11-O

**HC11-T**



SCHRANKE SYSTEMA-42-TIEFE-HC11-T

2

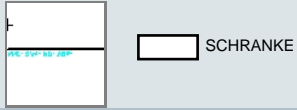

2.2



2.2.1

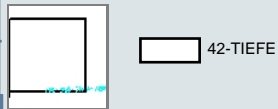

HC11-TS



SCHRANKE SYSTEMA-42-TIEFE-HC11-TS

HC55-O



SCHRANKE SYSTEMA-42-TIEFE-HC55-O

HC55-TL



SCHRANKE SYSTEMA-42-TIEFE-HC55-TL

HC55-TR

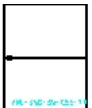

SCHRANKE SYSTEMA-42-TIEFE-HC55-TR

HC80-O



SCHRANKE SYSTEMA-42-TIEFE-HC80-O

HC80-T



SCHRANKE SYSTEMA-42-TIEFE-HC80-T

HC80-TS



SCHRANKE SYSTEMA-42-TIEFE-HC80-TS

2

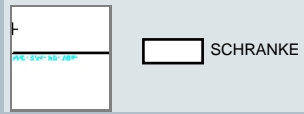

2.2

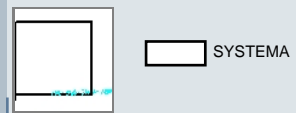

2.2.1

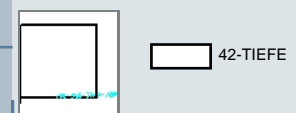

S-A-ABR



S-A11-O



S-A11-T



S-A11-TS



S-A55-O



S-A55-TL



S-A55-TR



2

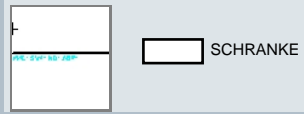

2.2

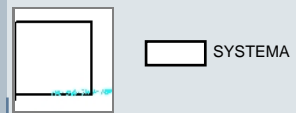

2.2.1

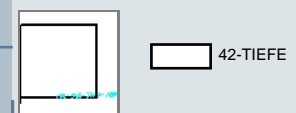

S-A80-O



S-A80-T



S-A80-TS



S-B-ABR



S-B11-O



S-B11-T



S-B11-TS



2

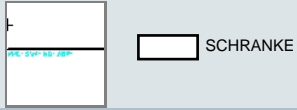

2.2



2.2.1

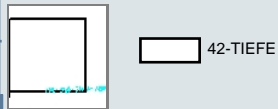

S-B55-O



SCHRANKE SYSTEMA-42-TIEFE-S-B55-O



S-B55-TL



SCHRANKE SYSTEMA-42-TIEFE-S-B55-TL



S-B55-TR



SCHRANKE SYSTEMA-42-TIEFE-S-B55-TR



S-B80-O



SCHRANKE SYSTEMA-42-TIEFE-S-B80-O



S-B80-T



SCHRANKE SYSTEMA-42-TIEFE-S-B80-T



S-B80-TS



SCHRANKE SYSTEMA-42-TIEFE-S-B80-TS



S-C-ABR



SCHRANKE SYSTEMA-42-TIEFE-S-C-ABR



2

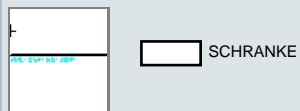

2.2



2.2.1

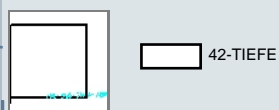

S-C11-O



SCHRANKE SYSTEMA-42-TIEFE-S-C11-O



S-C11-T



SCHRANKE SYSTEMA-42-TIEFE-S-C11-T



S-C11-TS



SCHRANKE SYSTEMA-42-TIEFE-S-C11-TS



S-C55-O

SCHRANKE SYSTEMA-42-TIEFE-S-C55-O



S-C55-TL



SCHRANKE SYSTEMA-42-TIEFE-S-C55-TL



S-C55-TR



SCHRANKE SYSTEMA-42-TIEFE-S-C55-TR

S-C80-2H



SCHRANKE SYSTEMA-42-TIEFE-S-C80-2H



2

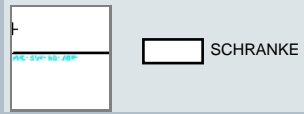

2.2

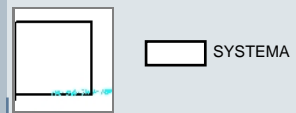

2.2.1

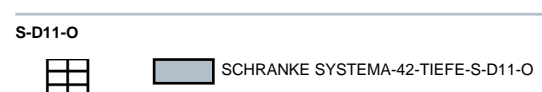
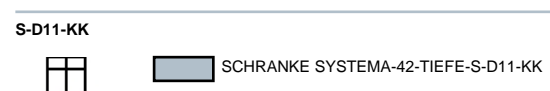
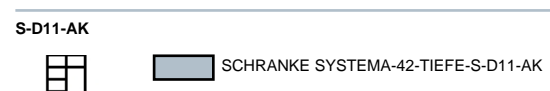
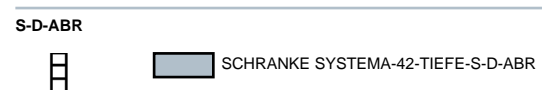
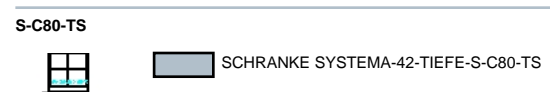
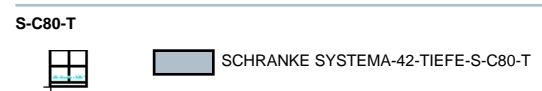
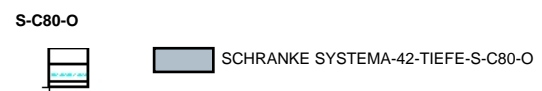
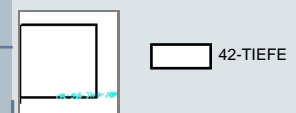



2

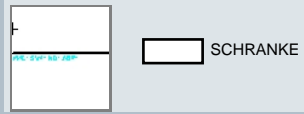

2.2

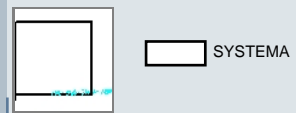

2.2.1

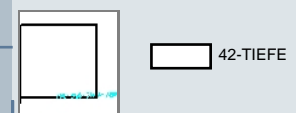

S-D11-T



SCHRANKE SYSTEMA-42-TIEFE-S-D11-T



S-D11-TO



SCHRANKE SYSTEMA-42-TIEFE-S-D11-TO



S-D11-TS



SCHRANKE SYSTEMA-42-TIEFE-S-D11-TS



S-D55-KL



SCHRANKE SYSTEMA-42-TIEFE-S-D55-KL



S-D55-KR



SCHRANKE SYSTEMA-42-TIEFE-S-D55-KR



S-D55-O



SCHRANKE SYSTEMA-42-TIEFE-S-D55-O



S-D55-TL



SCHRANKE SYSTEMA-42-TIEFE-S-D55-TL



2

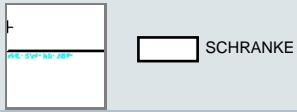

2.2



2.2.1

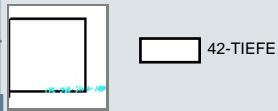

S-D55-TR



SCHRANKE SYSTEMA-42-TIEFE-S-D55-TR



S-D55TOL



SCHRANKE SYSTEMA-42-TIEFE-S-D55TOL



S-D55TOR



SCHRANKE SYSTEMA-42-TIEFE-S-D55TOR



S-D80-2H



SCHRANKE SYSTEMA-42-TIEFE-S-D80-2H



S-D80-2O



SCHRANKE SYSTEMA-42-TIEFE-S-D80-2O



S-D80-O



SCHRANKE SYSTEMA-42-TIEFE-S-D80-O



S-D80-T



SCHRANKE SYSTEMA-42-TIEFE-S-D80-T



2

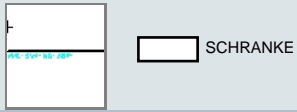

SCHRANKE

2.2



SYSTEMA

2.2.1

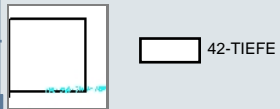

42-TIEFE

S-D80-TO



SCHRANKE SYSTEMA-42-TIEFE-S-D80-TO



S-D80-TS



SCHRANKE SYSTEMA-42-TIEFE-S-D80-TS



S-E-ABR



SCHRANKE SYSTEMA-42-TIEFE-S-E-ABR



S-E11-AK



SCHRANKE SYSTEMA-42-TIEFE-S-E11-AK



S-E11-KK



SCHRANKE SYSTEMA-42-TIEFE-S-E11-KK



S-E11-O



SCHRANKE SYSTEMA-42-TIEFE-S-E11-O



S-E11-T



SCHRANKE SYSTEMA-42-TIEFE-S-E11-T



# PARTsolutions

2

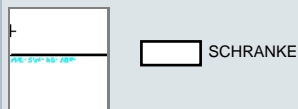

2.2



2.2.1

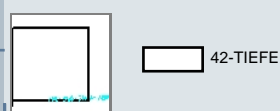

S-E11-TU



SCHRANKE SYSTEMA-42-TIEFE-S-E11-TU



S-E55-KL



SCHRANKE SYSTEMA-42-TIEFE-S-E55-KL



S-E55-KR



SCHRANKE SYSTEMA-42-TIEFE-S-E55-KR



S-E55-O



SCHRANKE SYSTEMA-42-TIEFE-S-E55-O



S-E55-TL



SCHRANKE SYSTEMA-42-TIEFE-S-E55-TL



S-E55-TR



SCHRANKE SYSTEMA-42-TIEFE-S-E55-TR



S-E55TUL



SCHRANKE SYSTEMA-42-TIEFE-S-E55TUL



2

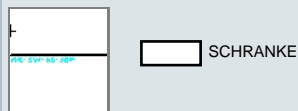

SCHRANKE

2.2



SYSTEMA

2.2.1



42-TIEFE

S-E55TUR



SCHRANKE SYSTEMA-42-TIEFE-S-E55TUR



S-E80-2H



SCHRANKE SYSTEMA-42-TIEFE-S-E80-2H



S-E80-2O



SCHRANKE SYSTEMA-42-TIEFE-S-E80-2O



S-E80-3H



SCHRANKE SYSTEMA-42-TIEFE-S-E80-3H



S-E80-O



SCHRANKE SYSTEMA-42-TIEFE-S-E80-O



S-E80-T



SCHRANKE SYSTEMA-42-TIEFE-S-E80-T



S-E80-TU



SCHRANKE SYSTEMA-42-TIEFE-S-E80-TU



2

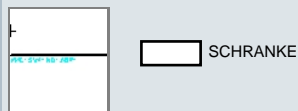

2.2



2.2.1

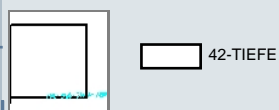

S-ECK-O



SCHRANKE SYSTEMA-42-TIEFE-S-ECK-O



S-ECK-TL



SCHRANKE SYSTEMA-42-TIEFE-S-ECK-TL



S-ECK-TR



SCHRANKE SYSTEMA-42-TIEFE-S-ECK-TR



SZ34



SCHRANKE SYSTEMA-42-TIEFE-SZ34

SZ35



SCHRANKE SYSTEMA-42-TIEFE-SZ35

SZ36



SCHRANKE SYSTEMA-42-TIEFE-SZ36

TUER-D-L



SCHRANKE SYSTEMA-42-TIEFE-TUER-D-L



# PARTsolutions

2

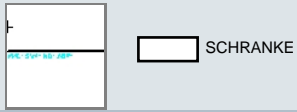

SCHRANKE

2.2



SYSTEMA

2.2.1

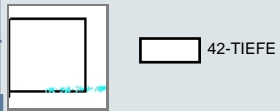

42-TIEFE

TUER-D-R



SCHRANKE SYSTEMA-42-TIEFE-TUER-D-R

TUER-DXL



SCHRANKE SYSTEMA-42-TIEFE-TUER-DXL

TUER-DXR



SCHRANKE SYSTEMA-42-TIEFE-TUER-DXR

TUER-IV

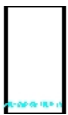

SCHRANKE SYSTEMA-42-TIEFE-TUER-IV

Z--FB-11



SCHRANKE SYSTEMA-42-TIEFE-Z--FB-11

Z--FB-55



SCHRANKE SYSTEMA-42-TIEFE-Z--FB-55

Z--FB-80



SCHRANKE SYSTEMA-42-TIEFE-Z--FB-80

# PARTsolutions

2

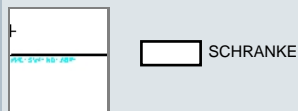

2.2



2.2.2

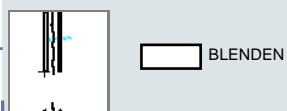

E-210B



SCHRANKE SYSTEMA-BLENDEN-E-210B

S-210LS



SCHRANKE SYSTEMA-BLENDEN-S-210LS

S-210RS



SCHRANKE SYSTEMA-BLENDEN-S-210RS

S-250L



SCHRANKE SYSTEMA-BLENDEN-S-250L

S-300L



SCHRANKE SYSTEMA-BLENDEN-S-300L

S-300LS



SCHRANKE SYSTEMA-BLENDEN-S-300LS

S-300R



SCHRANKE SYSTEMA-BLENDEN-S-300R



2

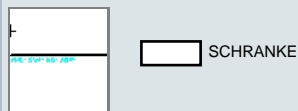

2.2



2.2.2



S-300RS



SCHRANKE SYSTEMA-BLENDE-S-300RS

VD-80-12



SCHRANKE SYSTEMA-BLENDE-VD-80-12

VD-80-20

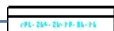

SCHRANKE SYSTEMA-BLENDE-VD-80-20

VD-80-30



SCHRANKE SYSTEMA-BLENDE-VD-80-30

W-250L



SCHRANKE SYSTEMA-BLENDE-W-250L

W-250R



SCHRANKE SYSTEMA-BLENDE-W-250R

W-300L



SCHRANKE SYSTEMA-BLENDE-W-300L

# PARTsolutions

2

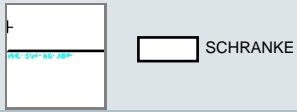

2.2



2.2.2



W-300R



SCHRANKE SYSTEMA-BLENDEN-W-300R

-

W2-300L



SCHRANKE SYSTEMA-BLENDEN-W2-300L

-

W2-300R



SCHRANKE SYSTEMA-BLENDEN-W2-300R

-

W3-210L



SCHRANKE SYSTEMA-BLENDEN-W3-210L

-

W3-210R



SCHRANKE SYSTEMA-BLENDEN-W3-210R

-

Z3-210



SCHRANKE SYSTEMA-BLENDEN-Z3-210

-

Z3-250



SCHRANKE SYSTEMA-BLENDEN-Z3-250

-

2

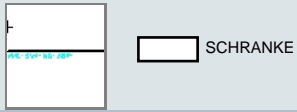

2.2



2.2.2

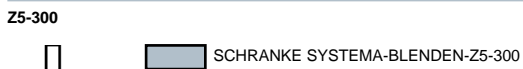
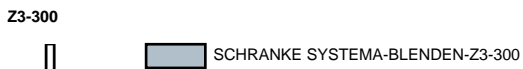

2.2.3



2

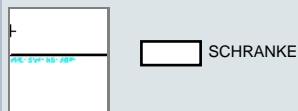

SCHRANKE

2.2



SYSTEMA

2.2.3



GLEIT-42

V-A11-T



SCHRANKE SYSTEMA-GLEIT-42-V-A11-T



V-A11-TS



SCHRANKE SYSTEMA-GLEIT-42-V-A11-TS



V-A55-O



SCHRANKE SYSTEMA-GLEIT-42-V-A55-O



V-A55-TL



SCHRANKE SYSTEMA-GLEIT-42-V-A55-TL



V-A55-TR



SCHRANKE SYSTEMA-GLEIT-42-V-A55-TR



V-A80-O



SCHRANKE SYSTEMA-GLEIT-42-V-A80-O



V-A80-T



SCHRANKE SYSTEMA-GLEIT-42-V-A80-T



2

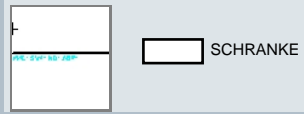

2.2

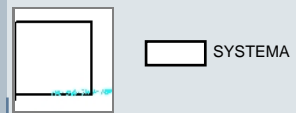

2.2.3



V-A80-TS



V-B-ABR



V-B11-O



V-B11-T



V-B11-TS



V-B55-O



V-B55-TL



# PARTsolutions

2

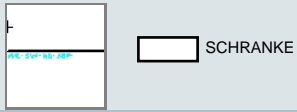

2.2



2.2.3



V-B55-TR



SCHRANKE SYSTEMA-GLEIT-42-V-B55-TR



V-B80-O



SCHRANKE SYSTEMA-GLEIT-42-V-B80-O



V-B80-T



SCHRANKE SYSTEMA-GLEIT-42-V-B80-T



V-B80-TS



SCHRANKE SYSTEMA-GLEIT-42-V-B80-TS



V-C-ABR



SCHRANKE SYSTEMA-GLEIT-42-V-C-ABR



V-C11-O



SCHRANKE SYSTEMA-GLEIT-42-V-C11-O



V-C11-T



SCHRANKE SYSTEMA-GLEIT-42-V-C11-T



2

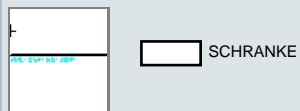

2.2



2.2.3



V-C11-TS



SCHRANKE SYSTEMA-GLEIT-42-V-C11-TS



V-C55-O



SCHRANKE SYSTEMA-GLEIT-42-V-C55-O



V-C55-TL



SCHRANKE SYSTEMA-GLEIT-42-V-C55-TL



V-C55-TR



SCHRANKE SYSTEMA-GLEIT-42-V-C55-TR



V-C80-2H



SCHRANKE SYSTEMA-GLEIT-42-V-C80-2H



V-C80-O



SCHRANKE SYSTEMA-GLEIT-42-V-C80-O



V-C80-T



SCHRANKE SYSTEMA-GLEIT-42-V-C80-T



2

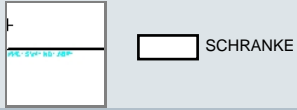

2.2



2.2.3



V-C80-TS



SCHRANKE SYSTEMA-GLEIT-42-V-C80-TS



V-D-ABR



SCHRANKE SYSTEMA-GLEIT-42-V-D-ABR



V-D11-AK



SCHRANKE SYSTEMA-GLEIT-42-V-D11-AK



V-D11-KK



SCHRANKE SYSTEMA-GLEIT-42-V-D11-KK



V-D11-O



SCHRANKE SYSTEMA-GLEIT-42-V-D11-O



V-D11-T



SCHRANKE SYSTEMA-GLEIT-42-V-D11-T



V-D11-TO



SCHRANKE SYSTEMA-GLEIT-42-V-D11-TO





2

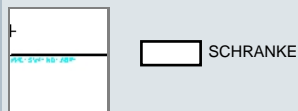

2.2

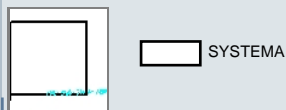

2.2.3



V-D11-TS



SCHRANKE SYSTEMA-GLEIT-42-V-D11-TS



V-D55-KL



SCHRANKE SYSTEMA-GLEIT-42-V-D55-KL



V-D55-KR



SCHRANKE SYSTEMA-GLEIT-42-V-D55-KR



V-D55-O



SCHRANKE SYSTEMA-GLEIT-42-V-D55-O



V-D55-TL



SCHRANKE SYSTEMA-GLEIT-42-V-D55-TL



V-D55-TR



SCHRANKE SYSTEMA-GLEIT-42-V-D55-TR



V-D55TOL



SCHRANKE SYSTEMA-GLEIT-42-V-D55TOL



2

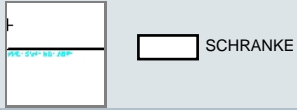

2.2

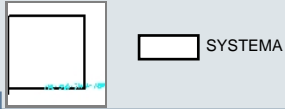

2.2.3



V-D55TOR



SCHRANKE SYSTEMA-GLEIT-42-V-D55TOR



V-D80-2H



SCHRANKE SYSTEMA-GLEIT-42-V-D80-2H



V-D80-2O



SCHRANKE SYSTEMA-GLEIT-42-V-D80-2O



V-D80-O



SCHRANKE SYSTEMA-GLEIT-42-V-D80-O



V-D80-T



SCHRANKE SYSTEMA-GLEIT-42-V-D80-T



V-D80-TO



SCHRANKE SYSTEMA-GLEIT-42-V-D80-TO



V-D80-TS



SCHRANKE SYSTEMA-GLEIT-42-V-D80-TS



2

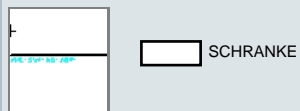

SCHRANKE

2.2



SYSTEMA

2.2.3



GLEIT-42

V-E-ABR



SCHRANKE SYSTEMA-GLEIT-42-V-E-ABR



V-E11-AK



SCHRANKE SYSTEMA-GLEIT-42-V-E11-AK



V-E11-KK



SCHRANKE SYSTEMA-GLEIT-42-V-E11-KK



V-E11-O



SCHRANKE SYSTEMA-GLEIT-42-V-E11-O



V-E11-T



SCHRANKE SYSTEMA-GLEIT-42-V-E11-T



V-E11-TU



SCHRANKE SYSTEMA-GLEIT-42-V-E11-TU



V-E55-KL



SCHRANKE SYSTEMA-GLEIT-42-V-E55-KL



# PARTsolutions

2

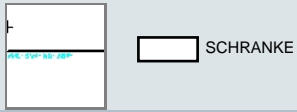

2.2



2.2.3



V-E55-KR



SCHRANKE SYSTEMA-GLEIT-42-V-E55-KR



V-E55-O



SCHRANKE SYSTEMA-GLEIT-42-V-E55-O



V-E55-TL



SCHRANKE SYSTEMA-GLEIT-42-V-E55-TL



V-E55-TR



SCHRANKE SYSTEMA-GLEIT-42-V-E55-TR



V-E55TUL



SCHRANKE SYSTEMA-GLEIT-42-V-E55TUL



V-E55TUR



SCHRANKE SYSTEMA-GLEIT-42-V-E55TUR



V-E80-2H



SCHRANKE SYSTEMA-GLEIT-42-V-E80-2H



2

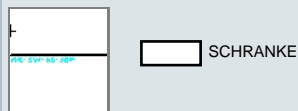

SCHRANKE

2.2



SYSTEMA

2.2.3



GLEIT-42

V-E80-20



SCHRANKE SYSTEMA-GLEIT-42-V-E80-20



V-E80-3H



SCHRANKE SYSTEMA-GLEIT-42-V-E80-3H



V-E80-O



SCHRANKE SYSTEMA-GLEIT-42-V-E80-O



V-E80-T



SCHRANKE SYSTEMA-GLEIT-42-V-E80-T



V-E80-TU



SCHRANKE SYSTEMA-GLEIT-42-V-E80-TU



V-ECK-O



SCHRANKE SYSTEMA-GLEIT-42-V-ECK-O



V-ECK-TL



SCHRANKE SYSTEMA-GLEIT-42-V-ECK-TL



2

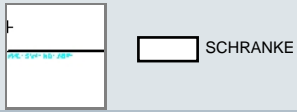

2.2

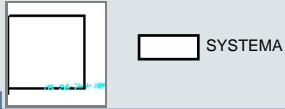

2.2.3



V-ECK-TR



SCHRANKE SYSTEMA-GLEIT-42-V-ECK-TR

2.2.4

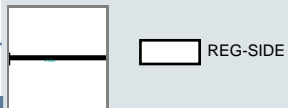

APL1-11

SCHRANKE SYSTEMA-REG-SIDE-APL1-11

APL1-16

SCHRANKE SYSTEMA-REG-SIDE-APL1-16

APL1-22

SCHRANKE SYSTEMA-REG-SIDE-APL1-22

APL1-24

SCHRANKE SYSTEMA-REG-SIDE-APL1-24

APL1-30

SCHRANKE SYSTEMA-REG-SIDE-APL1-30

2

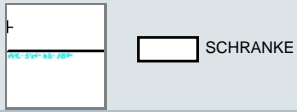

2.2

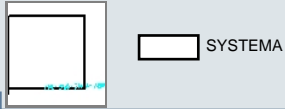

2.2.4

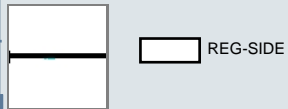

APL1-55

SCHRANKE SYSTEMA-REG-SIDE-APL1-55

APL1-80

SCHRANKE SYSTEMA-REG-SIDE-APL1-80

APL3-11

SCHRANKE SYSTEMA-REG-SIDE-APL3-11

APL3-16

SCHRANKE SYSTEMA-REG-SIDE-APL3-16

APL3-22

SCHRANKE SYSTEMA-REG-SIDE-APL3-22

APL3-24

SCHRANKE SYSTEMA-REG-SIDE-APL3-24

APL3-30

SCHRANKE SYSTEMA-REG-SIDE-APL3-30

2

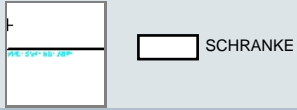

2.2



2.2.4

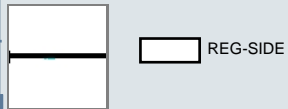

APL3-55

SCHRANKE SYSTEMA-REG-SIDE-APL3-55

APL3-80

SCHRANKE SYSTEMA-REG-SIDE-APL3-80

APL5-11

SCHRANKE SYSTEMA-REG-SIDE-APL5-11

APL5-16

SCHRANKE SYSTEMA-REG-SIDE-APL5-16

APL5-22

SCHRANKE SYSTEMA-REG-SIDE-APL5-22

APL5-24

SCHRANKE SYSTEMA-REG-SIDE-APL5-24

APL5-30

SCHRANKE SYSTEMA-REG-SIDE-APL5-30



2

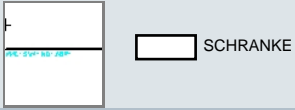

2.2

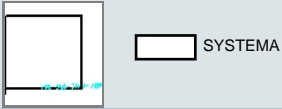

2.2.4

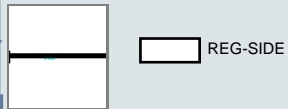

APL5-55

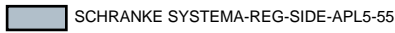

APL5-80

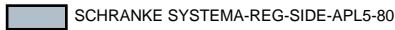

2.3

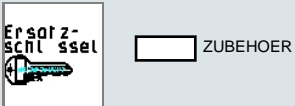

ERSATZ

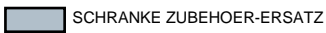

Er sat z-  
schl üssel

GARDEROB

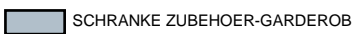

GLEIT-11

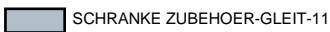

GLEIT-55

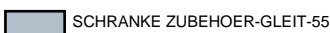

2



SCHRANKE

2.3

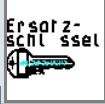

ZUBEHOER

GLEIT-80

SCHRANKE ZUBEHOER-GLEIT-80



HR-52-HT

SCHRANKE ZUBEHOER-HR-52-HT



HR-HT

SCHRANKE ZUBEHOER-HR-HT



KB-A4-HT

SCHRANKE ZUBEHOER-KB-A4-HT

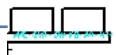

KB-A5-HT

SCHRANKE ZUBEHOER-KB-A5-HT



KB-A6-HT

SCHRANKE ZUBEHOER-KB-A6-HT



MAT-S-HT

SCHRANKE ZUBEHOER-MAT-S-HT

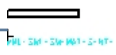

PENDEL11

SCHRANKE ZUBEHOER-PENDEL11



# PARTsolutions

2



SCHRANKE

2.3



ZUBEHOER

**PENDEL55**



SCHRANKE ZUBEHOER-PENDEL55

**PENDEL80**



SCHRANKE ZUBEHOER-PENDEL80

**SCHLOSS**



SCHRANKE ZUBEHOER-SCHLOSS

**SCHRAUBE**



SCHRANKE ZUBEHOER-SCHRAUBE

**SOCK-110**



SCHRANKE ZUBEHOER-SOCK-110

**SOCK-55**

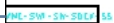

SCHRANKE ZUBEHOER-SOCK-55

**SOCK-80**



SCHRANKE ZUBEHOER-SOCK-80

**SPIEGEL**

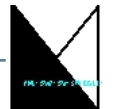

SCHRANKE ZUBEHOER-SPIEGEL

# PARTsolutions

2

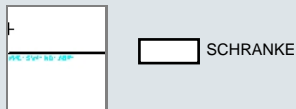

SCHRANKE

2.3

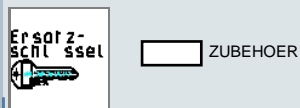

ZUBEHOER

SRW



SCHRANKE ZUBEHOER-SRW

Z-AFB-80

SCHRANKE ZUBEHOER-Z-AFB-80

## Content



- US Content of the CAD catalogue in PARTsolutions
- D Inhalt des CAD-Kataloges in PARTsolutions
- F Contenu du catalogue CAO dans PARTsolutions

- I Contenuto del catalogo nel PARTsolutions
- E Contenido del catálogo de CAD en PARTsolutions