

# Witte FixBase®

Brochure 2014<sup>E05</sup>

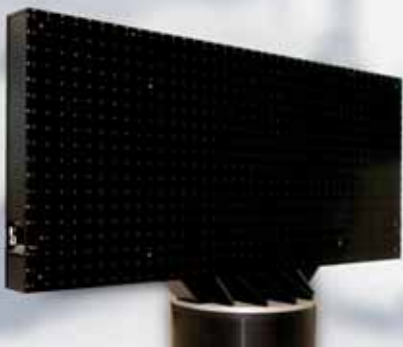

Mobile precision in XXL format

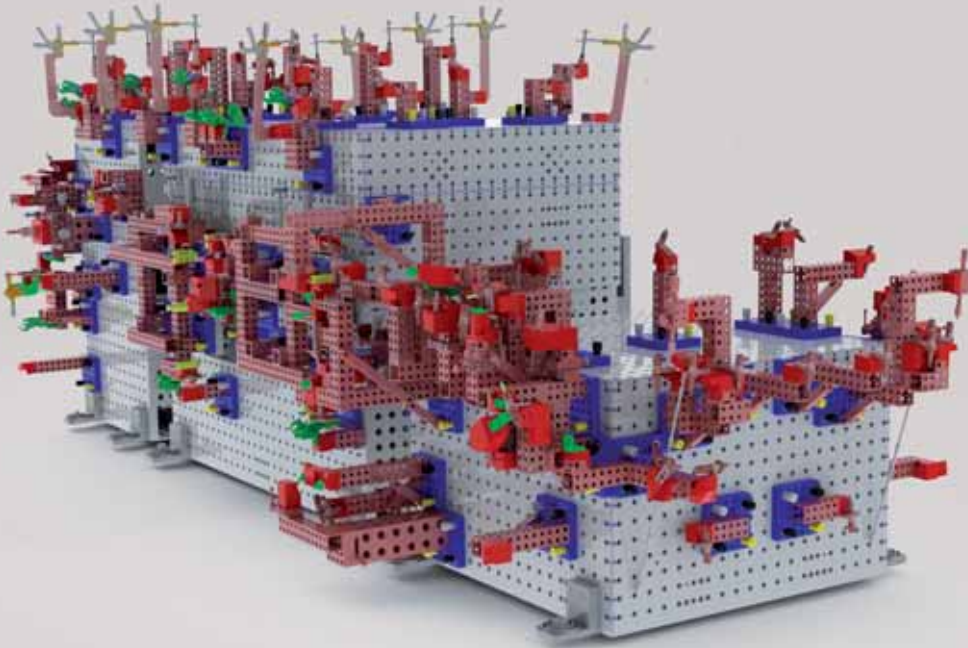

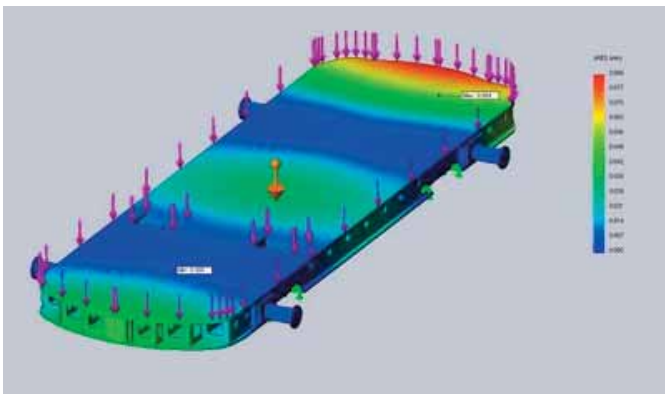
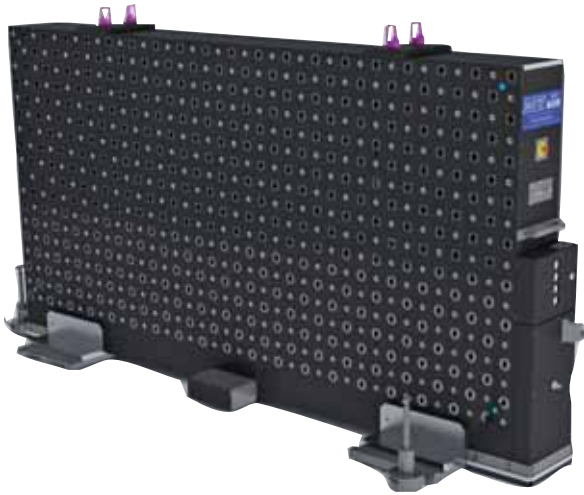

All sandwich plates are tested and optimized for capacity and rigidity according to FEM analysis

## Witte FixBase®

### Base plates and positioning systems

■ Accurate and very rigid Sandwich plates are used as bases for measuring or holding fixtures, as a cantilever for CMM measuring surfaces or as transport plates. They offer highest rigidity but are comparatively lightweight

■ Sandwich plates can be used vertically or horizontally.

■ Different types available  
- 2 (rib), 4 and 5 (standard)

■ According to customer request plates are available with natural or black anodized surface, hard coating is also possible.

■ Whether extremely lightweight and economical or very accurate and demanding one of our options will suit your company's needs. Almost any type of grid can be integrated into the plate surface/s.

■ Important accessories to large plates are PWS (Precision Witte System) or PPS (Precision Positioning System) quick clamp systems. These are systems integrated into the plate to allow quick, accurate and repeatable positioning of sub-plates or adapter plates onto the Sandwich plate.

■ Optional accessories i.e.

- Cable/radio remote control
- Camera
- Position sensors
- Visual and acoustic warning signals
- Laser-scanner to monitor area of movement

As well as special versions such as

- Contoured plates which fit to work piece, also three dimensional plates
- Contoured plates which fit to work piece, in segments or modular
- Mounted with moveable surface plates
- With integrated scissor trolleys are available on request



Vertical sandwich plate with hovercraft

**Witte FixBase®**  
Application examples

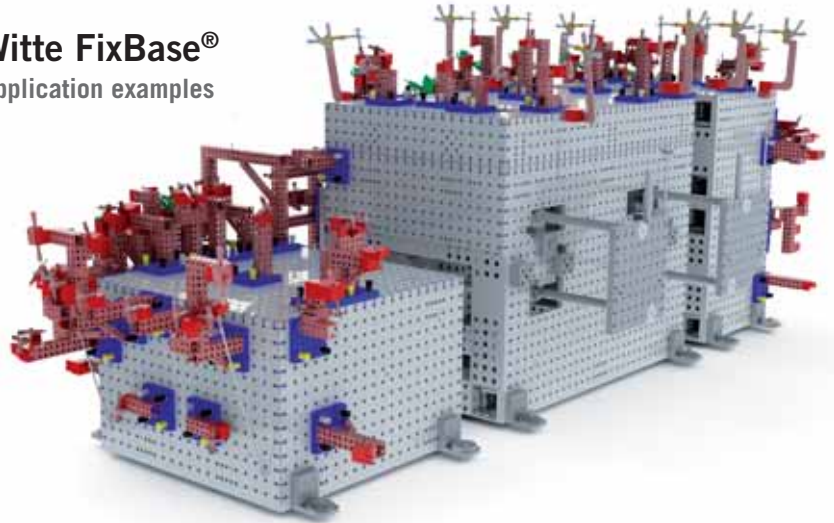

FixBase cube combination mounted with column type supports



Sandwich plate in combination with jack system for complete vehicles

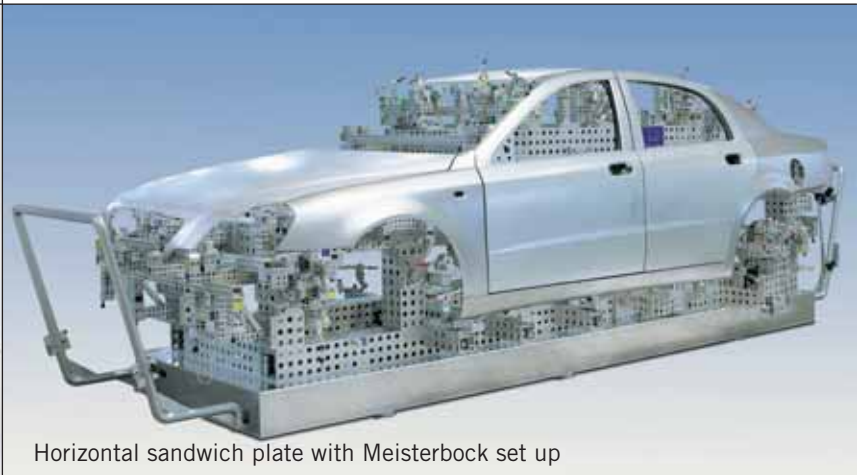

Horizontal sandwich plate with Meisterbock set up



Vertical sandwich plate with slide unit and exchangeable adapters for different car lengths

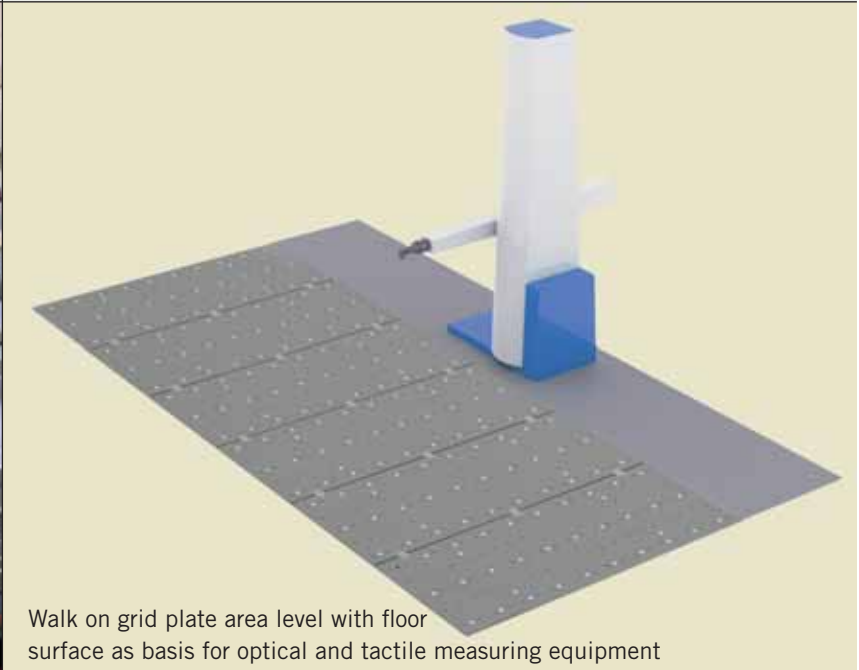

Walk on grid plate area level with floor surface as basis for optical and tactile measuring equipment



**Witte FixBase®** elements can be anodized in different colours. The colour natural is standard, black (-1) is available as an alternative. Other colours on request.

# Witte FixBase®

## Positioning:

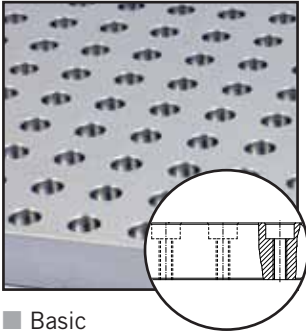

■ Basic thread w/o fitted sleeve

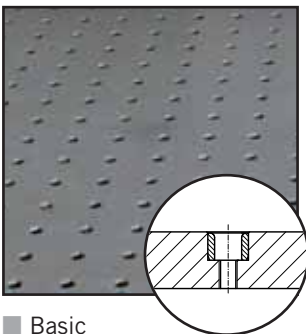

■ Basic thread with fitted sleeve

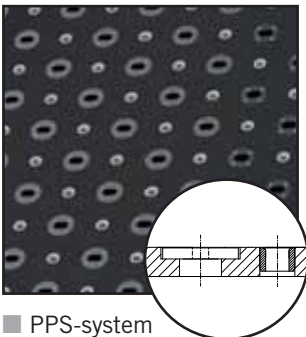

■ PPS-system

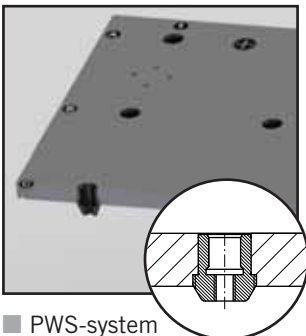

■ PWS-system

## Types:

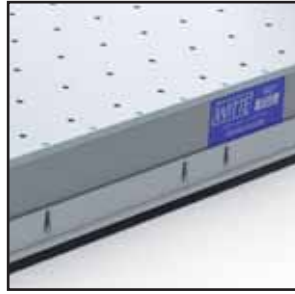

■ Single sandwich plate



■ Segment sandwich plate



■ Single grid base plate

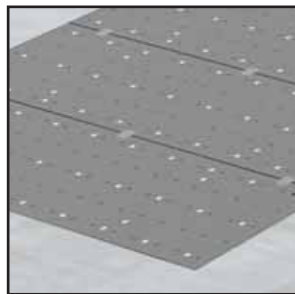

■ Grid plate area in segments



## Basic structure:



■ Standard



■ Rib type

# Plate versions

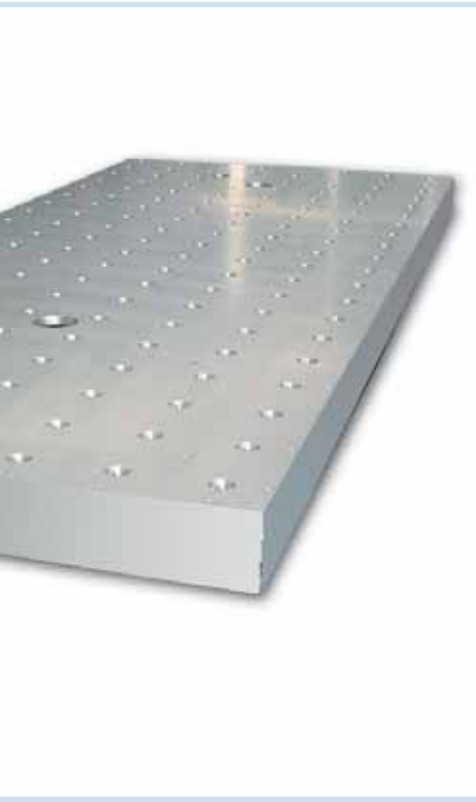

## Special design: (excerpt)

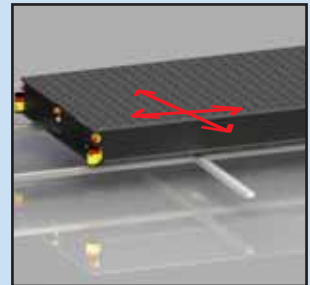

## Options: (excerpt)

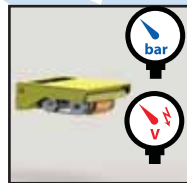
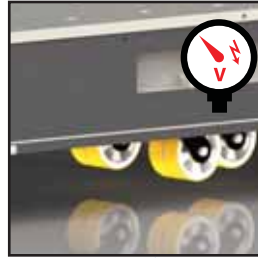
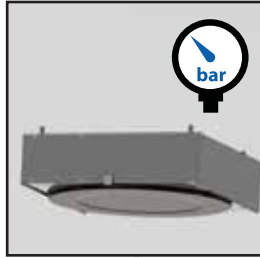



## FixBase Alu Sandwich Plate

### Type 2

Width	Length	Thick-ness	Thickness of sur-face plate w grid	Thickness of sur-face plate w/o grid	Grid	kg
800	1200	100	20	10	100	85
1000	2000	100	20	10	100	180
1200	1800	100	20	10	100	200
1600	2400	100	20	10	100	340

Above listed dimensions are examples, please state required dimensions and grid on your inquiry.

Top and bottom plates are connected with right angled profiles laid cross-wise inside and all round using a special adhesive resulting in a lightweight rigid sandwich plate.



Evenness acc. to DIN 876 II Gen 3 (up to 5m x 2m, tolerances for larger dimensions on request)

#### Grid:

- with or without
- one or two sided
- with or without steel sleeves
- with or without threaded helicoil inserts
- PWS
- PPS

Grid tolerance JS7, total tolerance JS8  
Available with higher accuracy on request

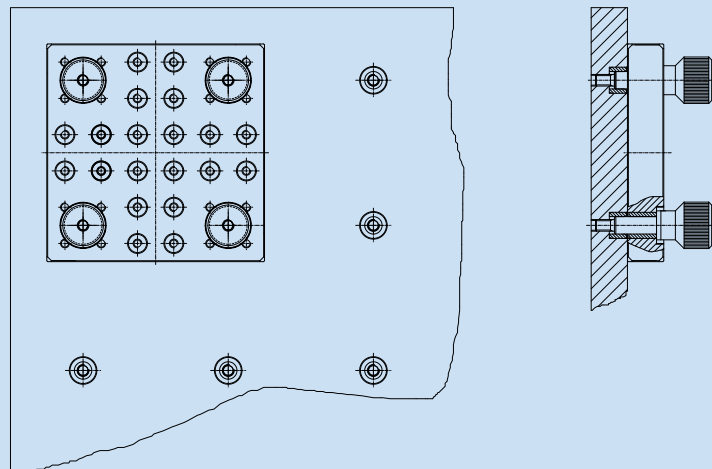

This type of sandwich plate is ideal for mounting adapter plates with locating screws

Max. Size of grid bores:  
System Alufix 25,  $\varnothing 12,5\text{mm}$  / M6

## FixBase Alu Sandwich Plate

Types 4 and 5, horizontal applications

Width	Length	Thick-ness	Thickness of sur- face plate w grid	Thickness of sur- face plate w/o grid	Grid	kg
1600	4000	150	25	25	100	980
2000	2000	150	25	25	100	620
2000	4000	150	25	25	100	1.220

Above listed dimensions are examples, please state required dimensions and grid on your inquiry.

Between surface plates aluminium spacer tubes are glued using a special adhesive. This method is especially suitable for manufacturing plates with complex grids, which are used horizontally or vertically.

Type 4 is without surface protection. Type 5 is anodized or hard anodized on request.



Evenness acc. to DIN 876 II Gen 3 (up to 5m x 2m, tolerances for larger dimensions on request)

Grid:

- with or without
- one sided
- with or without steel sleeves
- with or without threaded helicoil inserts
- PWS
- PPS

Grid tolerance JS7, total tolerance JS8  
Available with higher accuracy on request

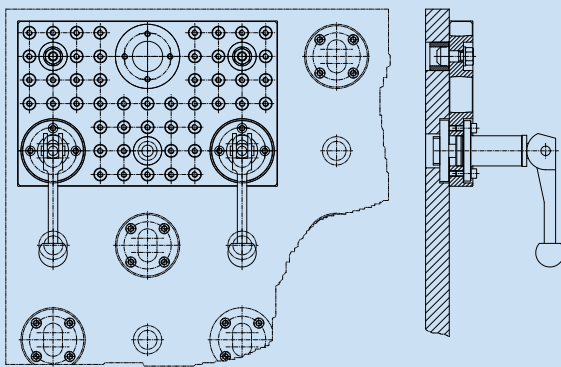

This type of sandwich plate is suitable for example for mounting PPS adapter plates



Witte FixBase® elements can be anodized in different colours. The colour natural is standard, black (-1) is available as an alternative. Other colours on request.

## FixBase Alu Sandwich Plate

Types 4 and 5, vertical applications

Between surface plates aluminium spacer tubes are glued using a special adhesive. This method is especially suitable for manufacturing plates with complex grids, which are used horizontally or vertically.

Type 4 is without surface protection.  
Type 5 is anodized or hard anodized on request.

Width	Length	Thick-ness	Thickness of sur- face plate w grid	Thickness of sur- face plate w/o grid	Grid	kg
1800	3600	300	25	25	100	1.150
2000	2000	300	25	25	100	760
2000	4000	300	25	25	100	1.450

Above listed dimensions are examples, please state required dimensions and grid on your inquiry.

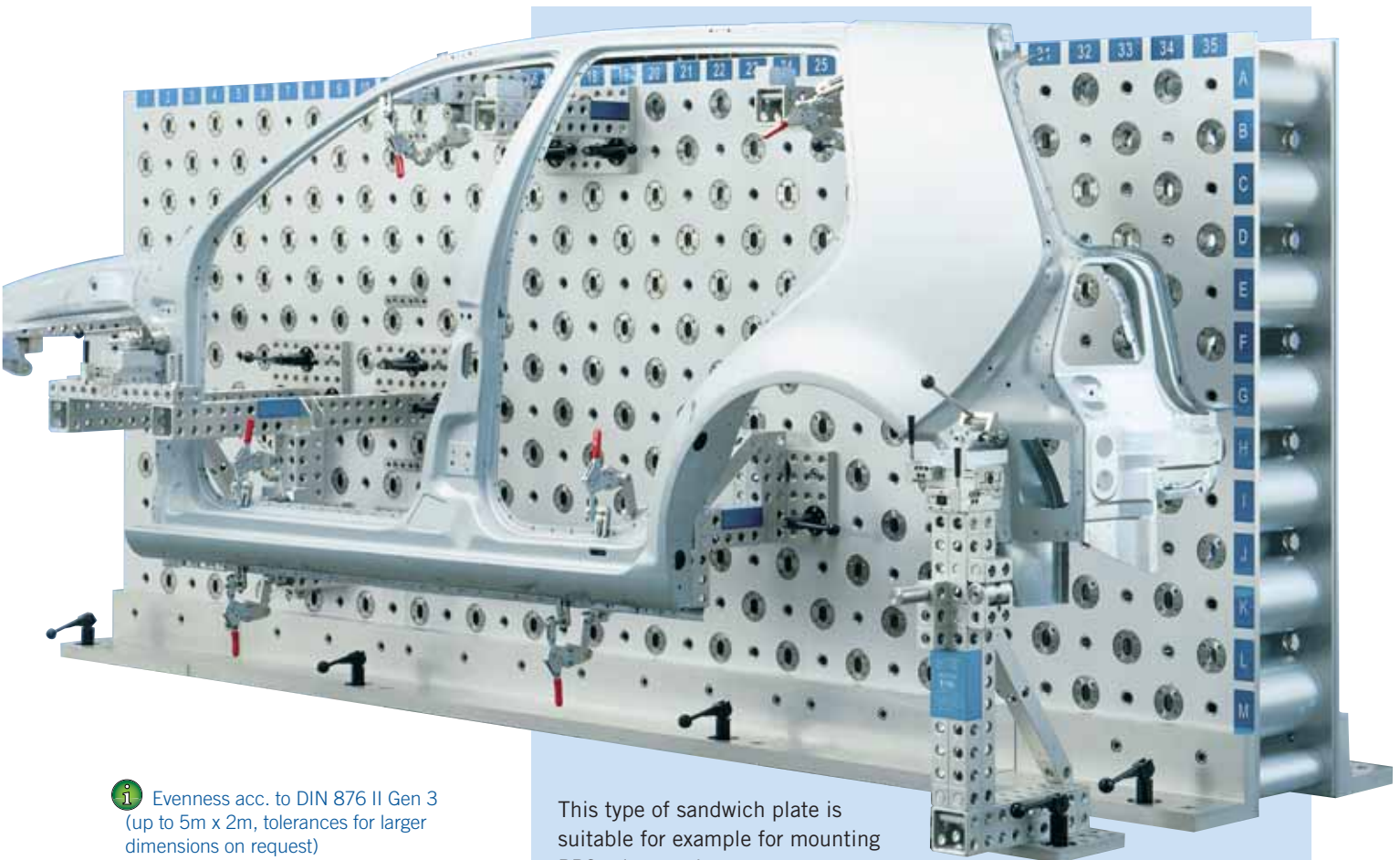

Evenness acc. to DIN 876 II Gen 3 (up to 5m x 2m, tolerances for larger dimensions on request)

Grid:

- with or without
- one or two sided
- with or without steel sleeves
- with or without threaded helicoil inserts
- PWS
- PPS

Grid tolerance JS7, total tolerance JS8  
Available with higher accuracy on request

This type of sandwich plate is suitable for example for mounting PPS adapter plates

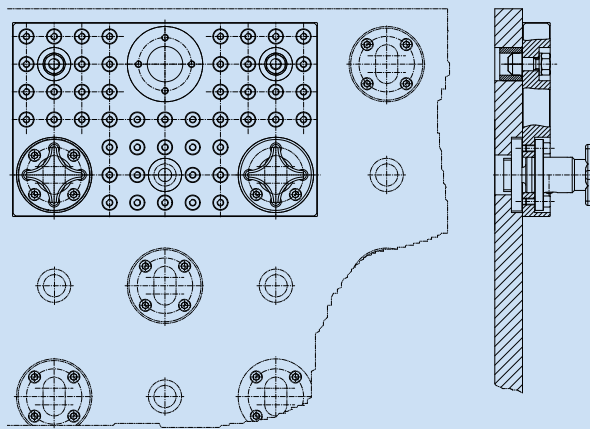



## FixBase Rib Sandwich Plate

Type 2 for horizontal and vertical applications

- 30% increased rigidity with same thickness or same rigidity with less thickness
- enable more flexible design i.e. large cutouts, surface plate in sections or without bottom plate
- larger sizes and/or heavy loads (up to 6000 x 3000mm or 2to./m<sup>2</sup>)

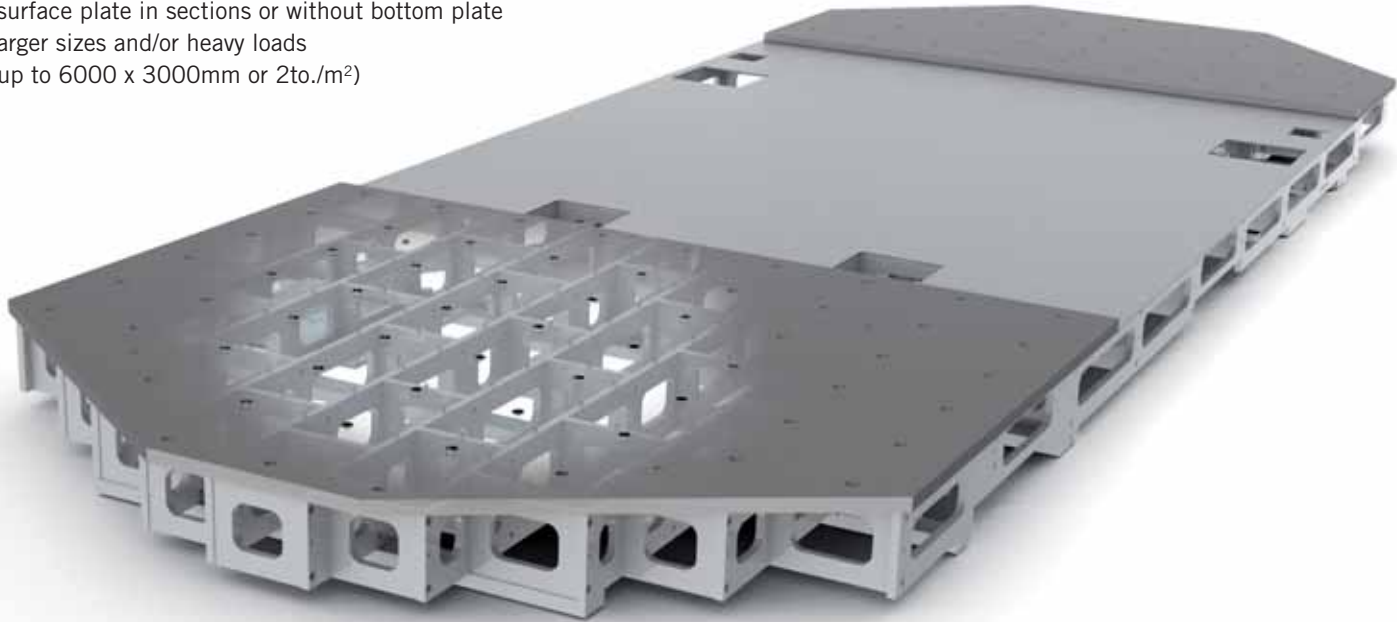

Dimensions on request.

Evenness acc. to DIN 876 II Gen 3 (up to 5m x 2m, tolerances for larger dimensions on request)

Grid:

- with or without
- one or two sided
- with or without steel sleeves
- with or without threaded helicoil inserts
- PWS
- PPS

This type of sandwich plate is suitable for example for mounting PWS adapter plates

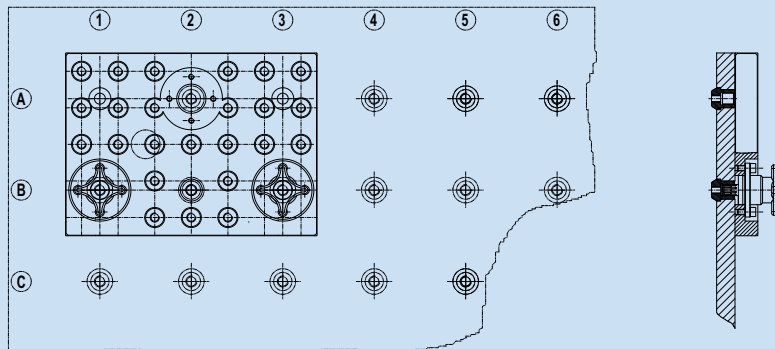

Grid tolerance JS7, total tolerance JS8  
Available with higher accuracy on request



Witte FixBase® elements can be anodized in different colours. The colour natural is standard, black (-1) is available as an alternative. Other colours on request.

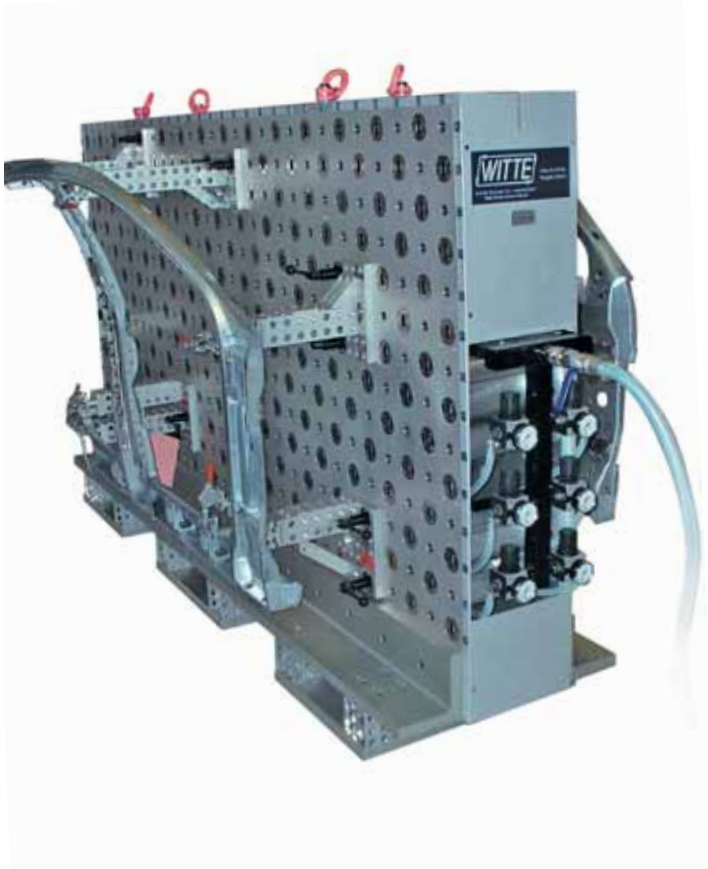

## Alu Sandwich Plate with hovercraft hose connected

Sandwich plates can be Witte-equipped with a hovercraft cushion system. This enables easy and quick transport of the plate from loading area to checking area (CMM surface area). Even plates with heavy loads can easily be moved over cracks, seams or ridges in the floor. Air pressure is individually regulated to adjust to irregular weight distribution guaranteeing a smooth and even ride.

For effective and problem free performance of hovercraft systems, a smooth non porous surface i.e. plastic coated, ground cement or vinyl flooring is ideal. Please contact us for specifications to ensure proper function in your facility.



Hovercraft cushion cassette shown on underside of plate

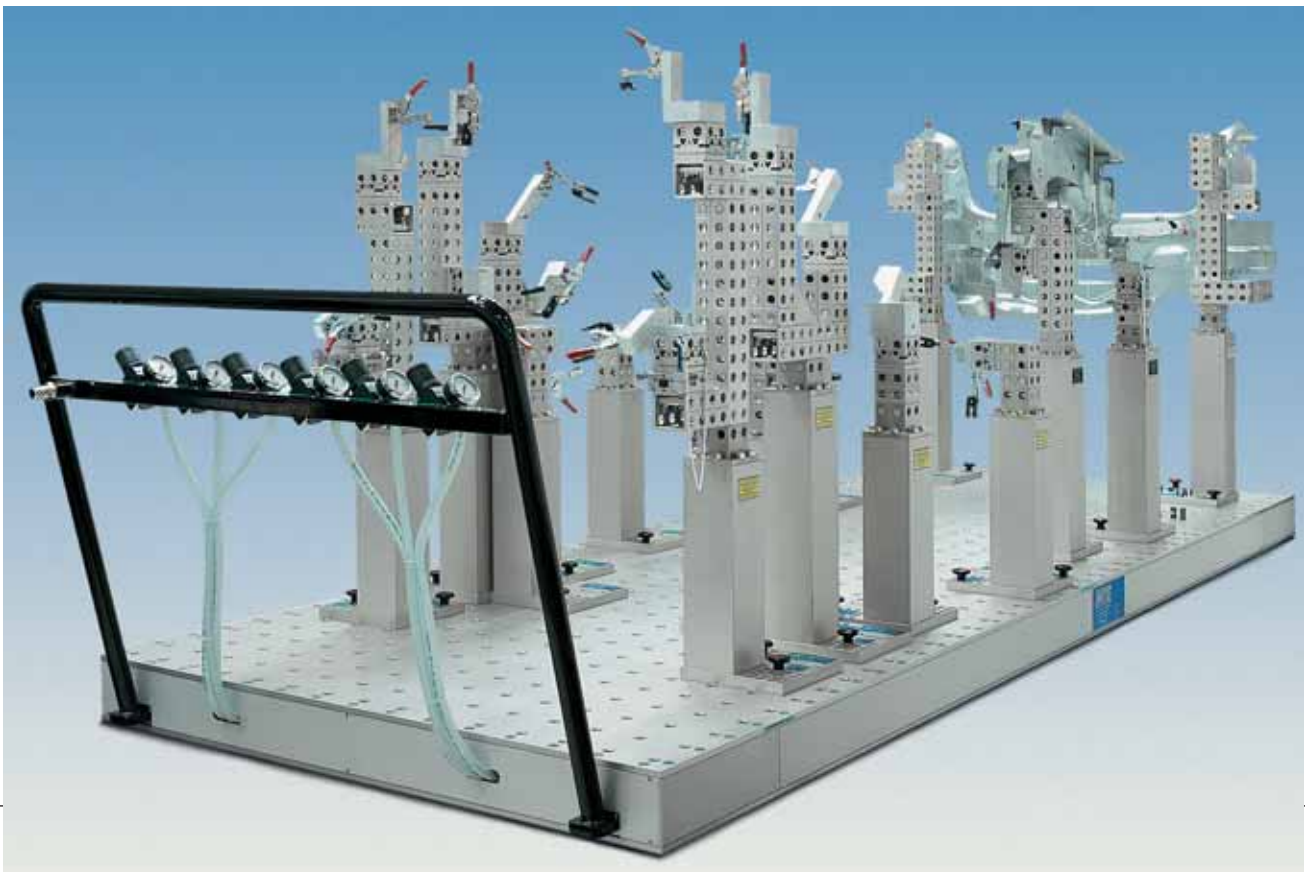



## Alu Sandwich Plate with hovercraft

Independent, operation with integrated air tanks

A special way of moving sandwich plates is by using intergrated air storage system. Internal pressure cylinders allow self sufficient plate movements meaning that no air supply hose is necessary. Besides increased mobility it also adds to flexibility.

The air reservoir system is designed for a drive mode for a minimum of 2 minutes. Filling up of the reservoir (max 12 bar) is completed after a short period of time. Depending on floor conditions drive mode of 2 minutes can often be exceeded.

This option for Witte Sandwich plates has to be integrated into initial design and purchase of a plate. The air storage system cannot be re-tooled or added to a plate at a later date.

-  Minimum plate thickness 250mm  
Reloading via normal house circuit  
Low working pressure (max 20 bar)  
No high pressure compressor system required
-  Safe, low-maintenance and economical complete concept



 Witte FixBase® elements can be anodized in different colours. The colour natural is standard, black (-1) is available as an alternative. Other colours on request.



## Alu Sandwich Plates

### with friction wheel drive

Sandwich plate types 4 and 5 can additionally be equipped with electrically or pneumatically driven friction wheels. Advantages are

- Secure repeatable positioning
- Easy handling with no strong effort required
- Drive and brake function

Further optional safety accessories

- Camera
  - Position sensors
  - Visual and acoustic warning signals
  - Laser-scanner to monitor area of movement
- Hovercraft system is a pre-requisite for this type of drive.

A direct drive as well as a hovercraft system are options for newly designed plates. Both can be integrated into plates already in use. There are pneumatic and electrically driven versions available.



## Electro-Mover

### Shunting and drive accessory for plates without any power unit

- For moving hovercraft and roller plates
- Hooked up using ball shaped scraper
- Pull and push operation possible
- Electro drive with battery charger for up to two hours continuous use



## XXL – Grid plate area

Example of floor level area using grid base plates with full surface grid

Options:

- one or more segments
- max. segment size 2000x4000 mm
- unlimited total surface area
- integrated into floor or mounted on customer's CMM surface
- single segments aligned to each other or complete surface aligned to measuring volume

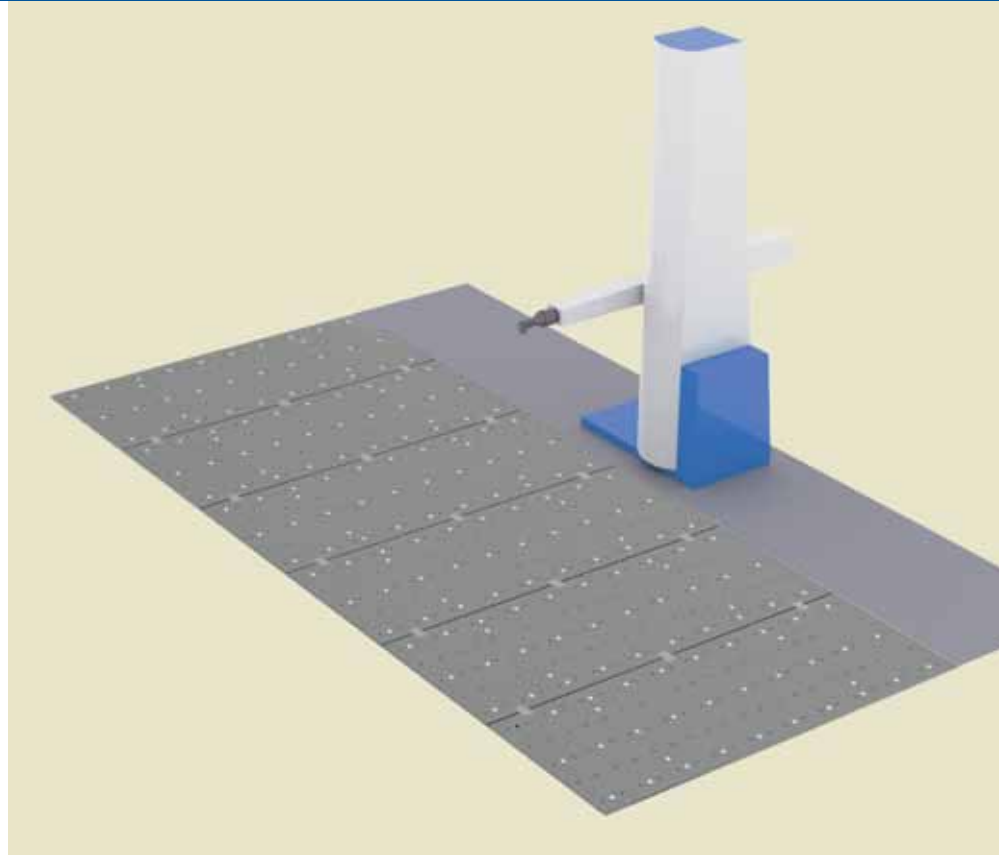

## XXL – Sandwich plate area

Example of mounted sandwich plate segments

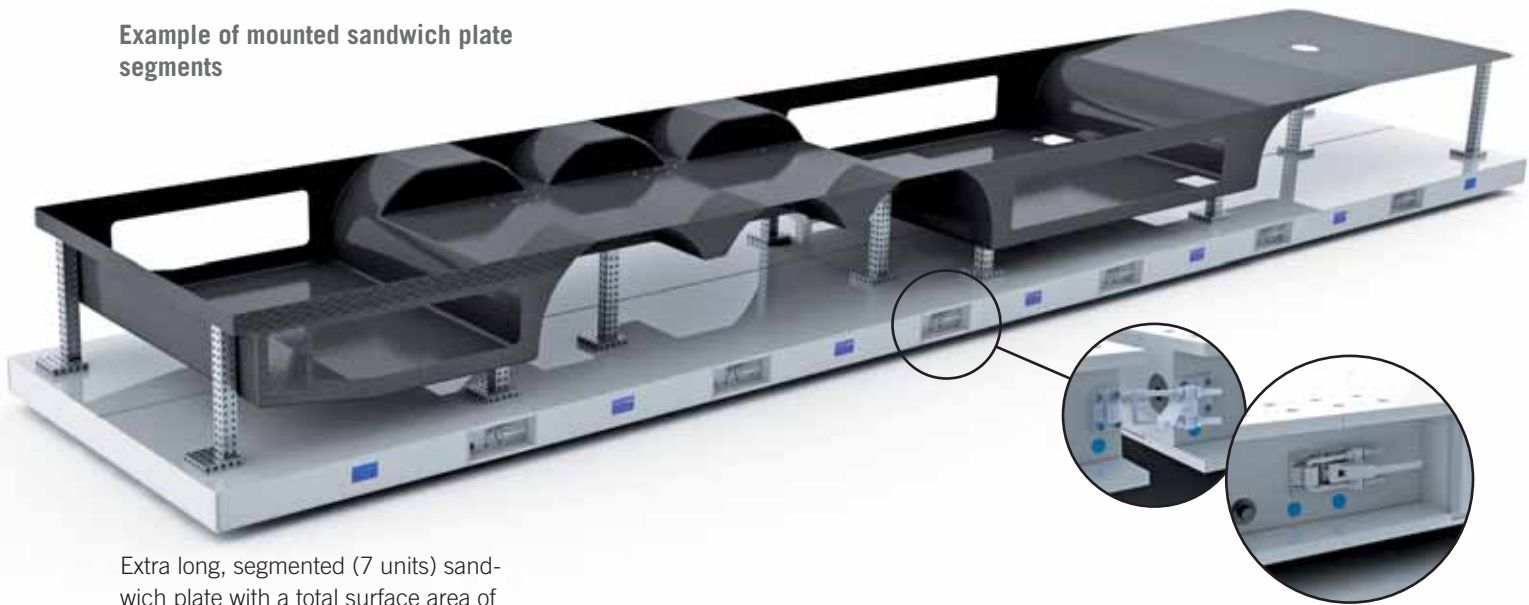

Extra long, segmented (7 units) sandwich plate with a total surface area of 2,5x14m, coupled using centering pins and shackle clamps. Serves as platform for laminating CFP semi-trailer (mono-coque). Single plates coupled using centering pins and pull clamps. Can be equipped with hovercraft, provided floor surface is suitable



 Witte FixBase® elements can be anodized in different colours. The colour natural is standard, black (-1) is available as an alternative. Other colours on request.

## Alu Sandwich Plates

rotating

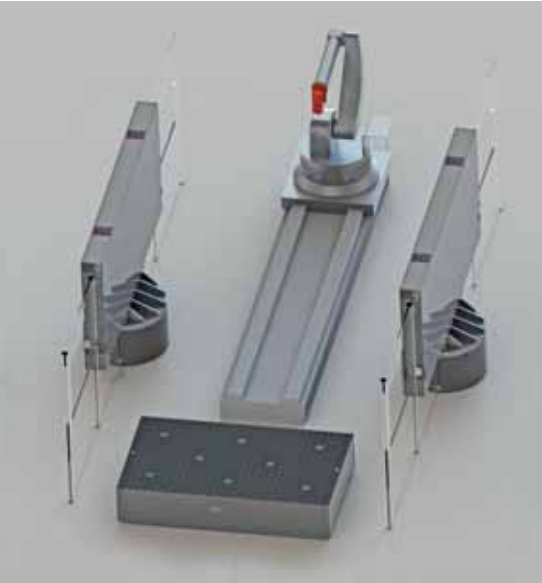

Robot measuring cell for optical measuring

Configuration:

- 2 vertical sandwich plates mounted on rotating hovercraft supports, rotatable by 180°
- 1 stationary, horizontal sandwich plate with extended height
- On hovercraft, rotary and tact tables
- To reach both work pieces or do assembly from outside without interrupting measuring process
- Integrated safety monitoring, release switch

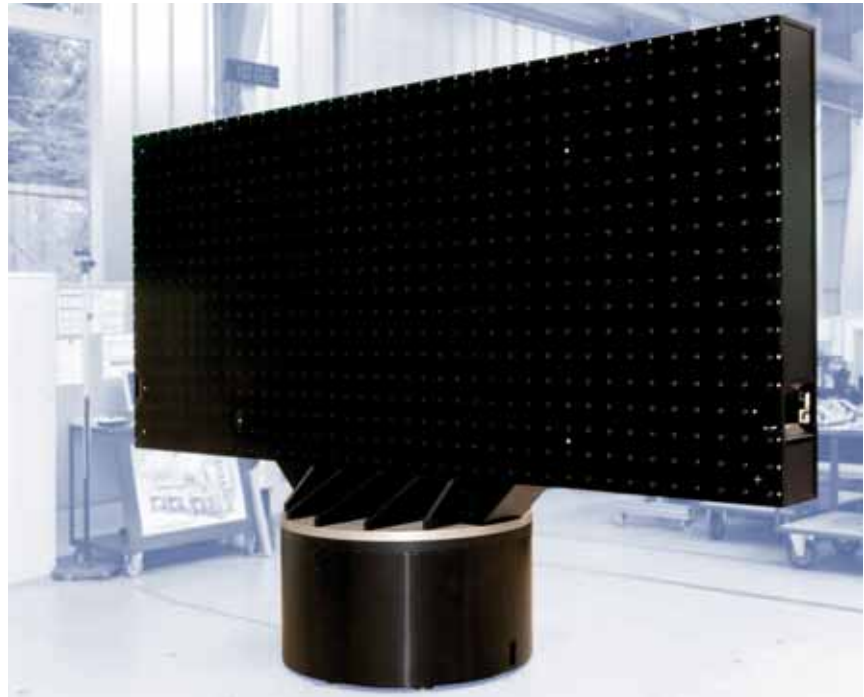

Vertical alu sandwich plate on hovercraft rotary table

Horizontal sandwich plate on motorized rotary table (shown without base unit). Force is directed to the rotary plate via inner plate structure

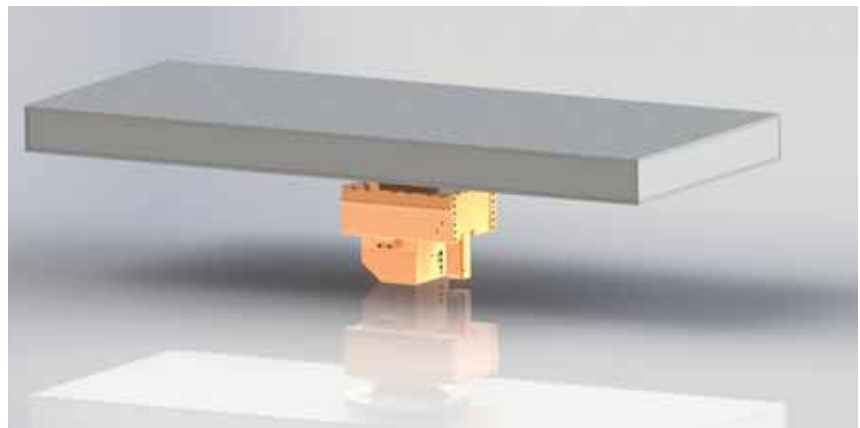

## Alu Sandwich Plates

height-adjustable

Motor driven height adjustable sandwich plate for parallel use of tactile and photogrammetry measuring tasks.

Example configuration on the right:

- 750 mm lift from 2050 to 2800 mm.
- Clamping surface on both sides 3700 x 1700 mm
- Hovercraft with direct drive
- Double sided PPS grid
- Walk-on base for easy use of plate
- Grid surface anodized black
- Equipped with safety features, hook-eyes, emergency stop on both face ends and allround foot protection

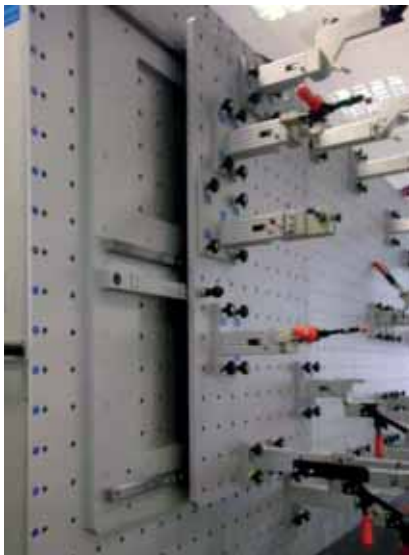
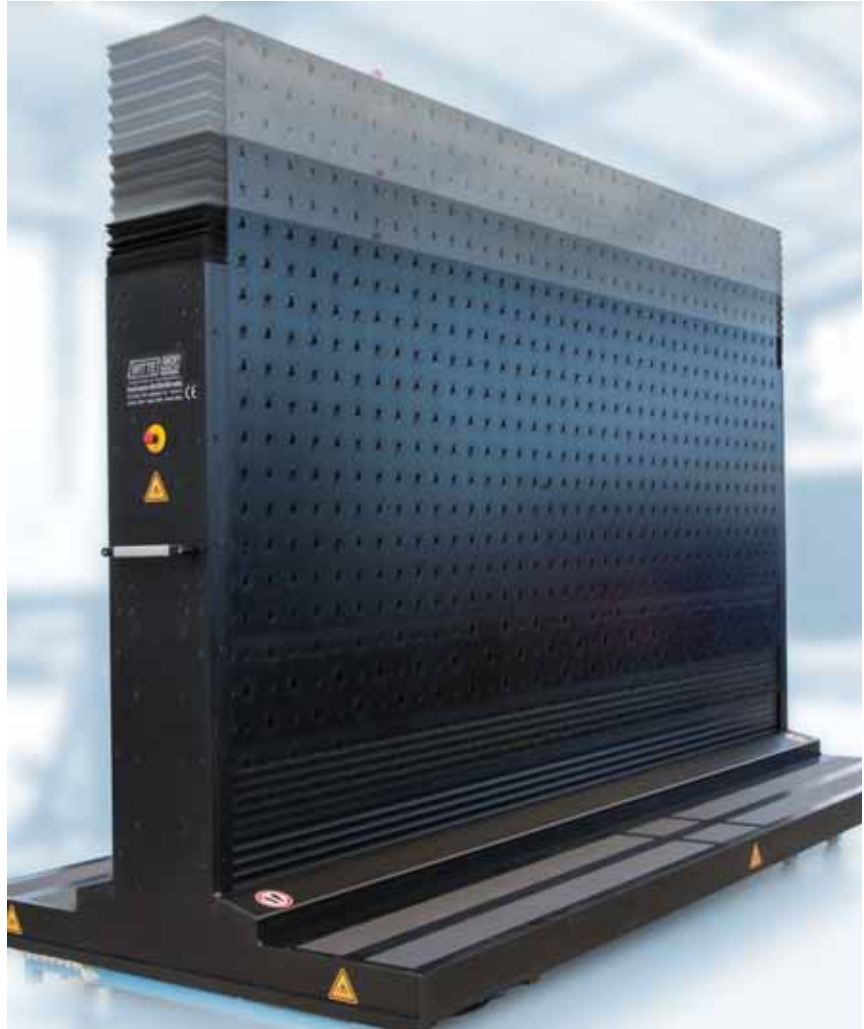

## Slide units

optional

Versions:

- mounted or integrated
- for vertical and horizontal sandwich plates
- mounted version possible for plates already in use
- freely selectable grid
- fixed positions using pins



 **Witte FixBase®** Elemente können in unterschiedlichen Farben eloxiert geliefert werden. Die Farbe „Natur“ ist Standard, „Schwarz“(-1) ist alternativ lieferbar. Weitere Farben auf Anfrage

## AluSandwich Roller Plate

with floating heavy duty guided rollers



View from underneath

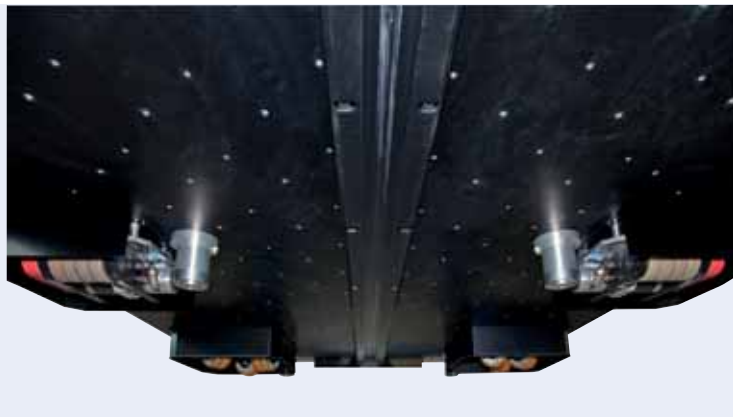

### Applications:

- For uneven, porous or joined (tiled) floors
- If no air pressure is available or current operations will be adversely affected

### Characteristics:

- Automatic crawl speed when reaching final position

### Equipment options:

- Direct drive or E-Mover drive
- Camera with integrated screen



Control panel with camera monitor



## Positioning and parking systems

### for moveable alu sandwich plates

For repeatable, accurate positioning of sandwich plates in a measuring machine area we offer a positioning system which is embedded into the floor.

It comprises of Z supports, a centering unit for X and a further locating unit for XY direction.

The units are installed in the floor, anchored and covered with metal disks. The Z supports are aligned to exactly the same height, the X and XY are spaced and aligned to the length axis of the CMM. The units are so rigid, they securely and accurately position sandwich plates over a long period of time.

For simple and secure pre-positioning a rail guide with a centering inlet and an end stop can be installed.

For sandwich plates equipped with electric, pneumatic or hydraulic systems an energy saving automatic multi-coupling can be integrated in the end stop in plate operating position.

Monitoring of whether or where plate is located is possible using inductive gap sensors.

Parking systems with simple Z supports without covers are available for setting down plate outside of measuring area.

The supports are installed in the floor using compound adhesive and aligned to the same height. They are so strong that sandwich plates can be lowered and parked there for a long time if necessary without any risk of deforming the plate.

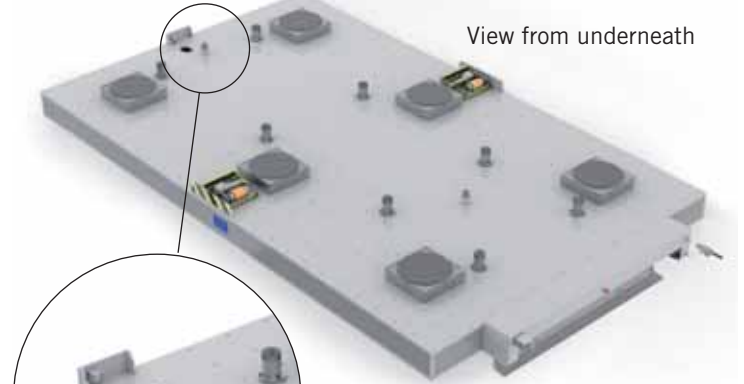

View from underneath

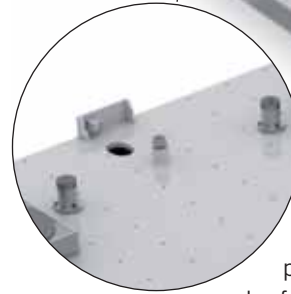

Undersurface of Witte FixBase sandwich plate with hovercraft cushion cassette, friction drive and positioning system. Detail shows roller for rail guide and end stop with inductive gap sensor.

Positioning system with guide rail and stop on a measuring machine



End stop with centering pin

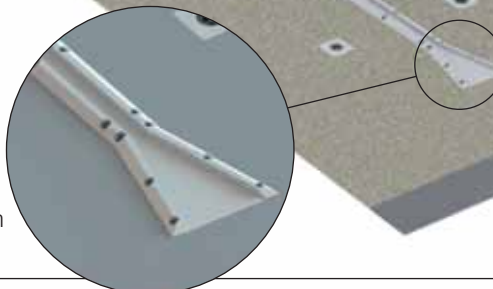

Rail guide with centering inlet



Witte FixBase® Elemente können in unterschiedlichen Farben eloxiert geliefert werden. Die Farbe „Natur“ ist Standard, „Schwarz“(-1) ist alternativ lieferbar. Weitere Farben auf Anfrage



- For fully automatic controlled loading stations
- Quiet forcibly guided run rails embedded in the floor
- No edges or grooves to stumble over
- 90° cross operation due to correspondingly arranged pivoting wheels
- Electro drive with battery operation
- Position monitoring/controlling with RFID transponders and IW-LAN radio network
- Positioning in CMM by lowering on to centering rings

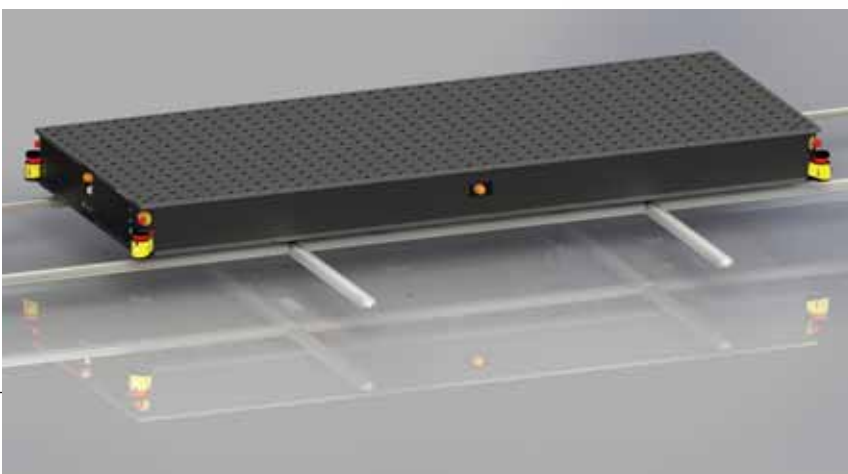
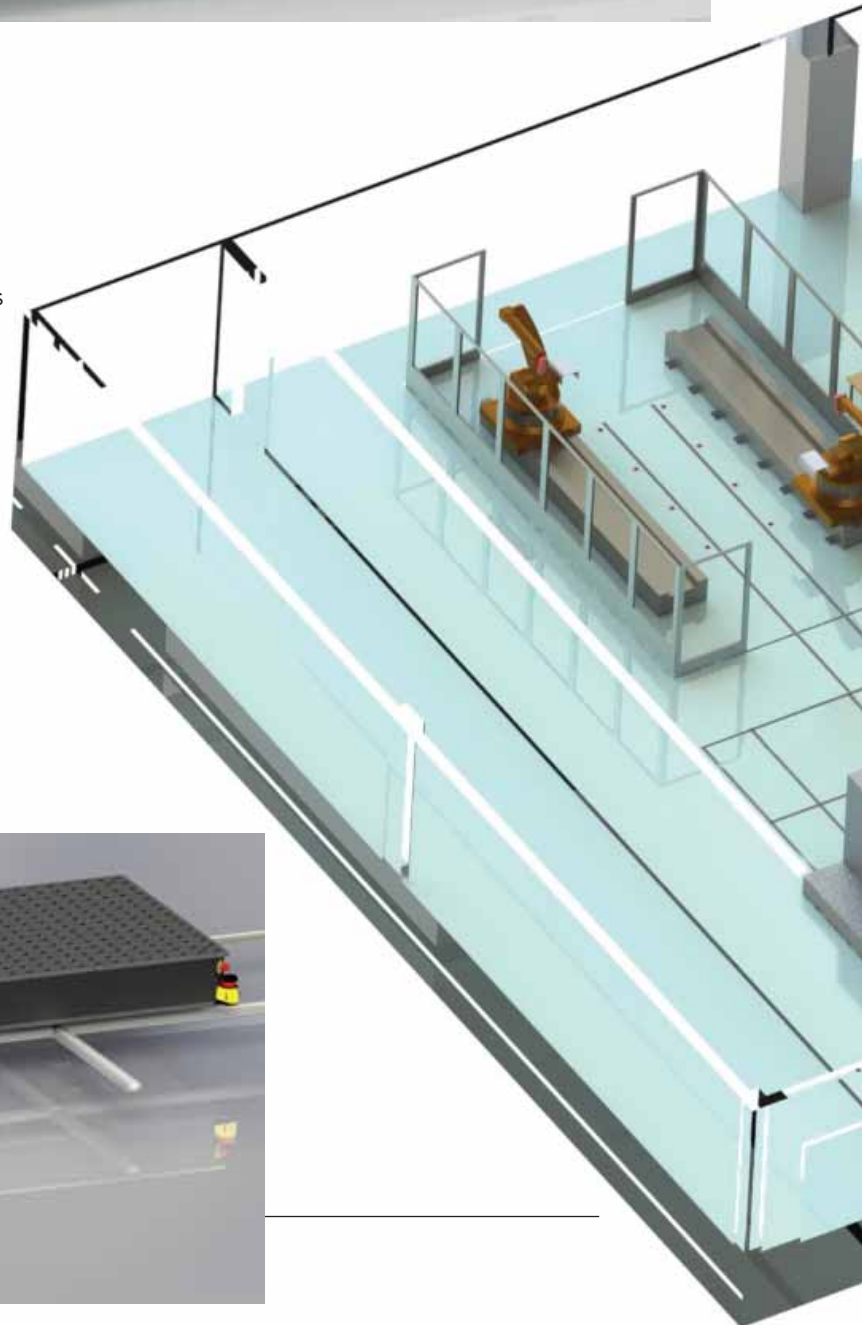

## Witte FixBase® Special solutions

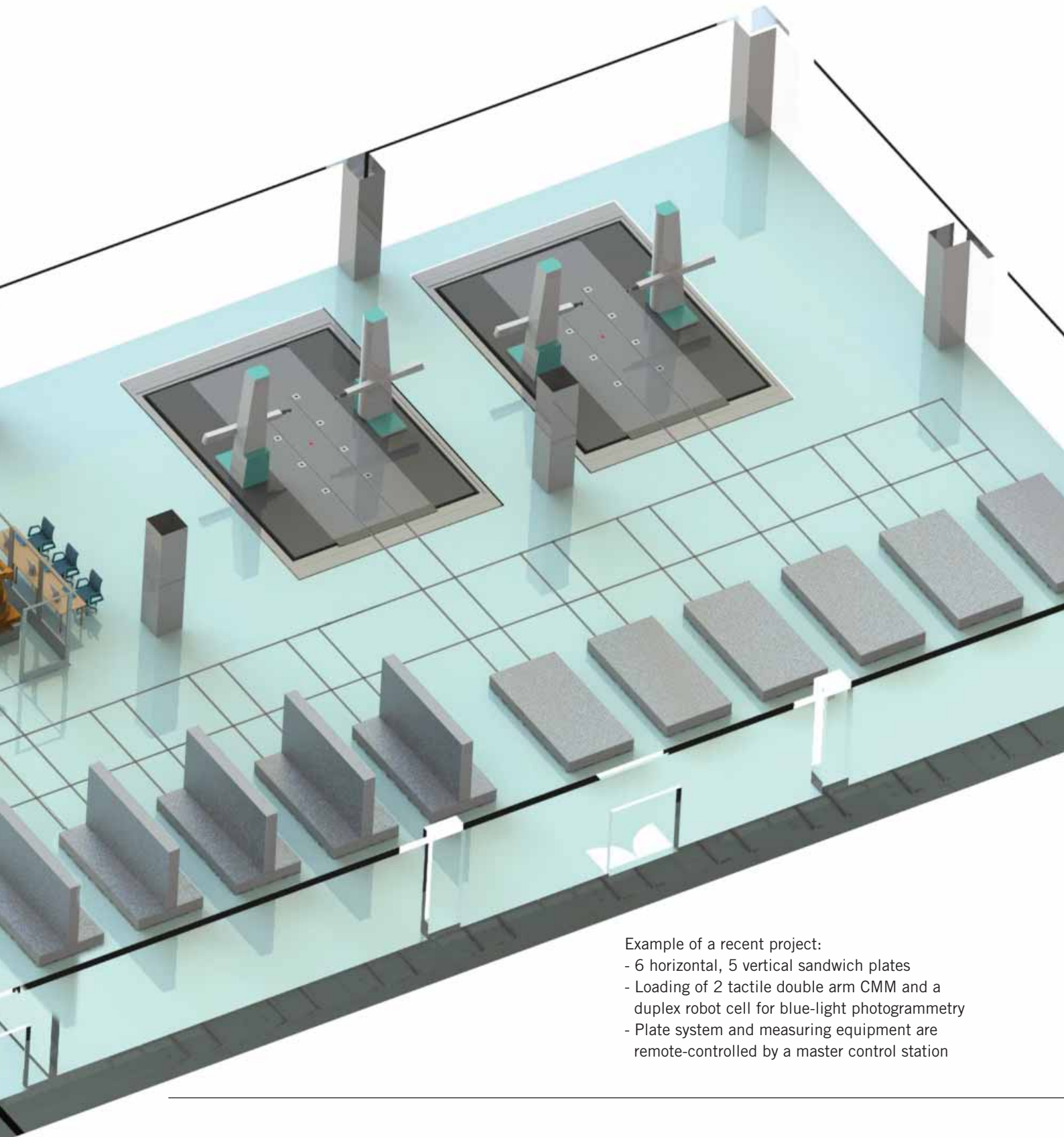

Example of a recent project:

- 6 horizontal, 5 vertical sandwich plates
- Loading of 2 tactile double arm CMM and a duplex robot cell for blue-light photogrammetry
- Plate system and measuring equipment are remote-controlled by a master control station

## Alu sandwich plates Special solutions



Complete vehicle unit for inspection and measuring of test cars or cars due for delivery. The vehicle is either driven or pulled onto the plate using a winch. After scissor trolleys raise the vehicle it is set down on RPS or car jack up points.



The sandwich plate is equipped with hovercraft and as an option can be driven with friction wheels. Scissor trolleys and winch are power operated.



## Alu sandwich plates Heavy-duty version

Rib type alu sandwich plates can be designed especially for heavy loads. The picture on the left shows a hovercraft sandwich plate with dimensions 2000x4000x300mm. The plate itself weights 1,5 tons and total load capacity is 15 (fifteen!) tons.

Fully loaded the plate can be moved by two people. When using an Electric-Mover only one person is required.

## FixBase® Boxes

- Boxes mounted with grid plates:
- Grid with fitted bores
- Flat, full surface grid on 5 sides
- Boxes in different or same sizes can be joined together or used individually
- Maximum dimensions 3.000x1.500x2.000mm
- Further functions can be integrated into the cubes i.e. door supports which move outwards, hood or tail-gate supports which upwards

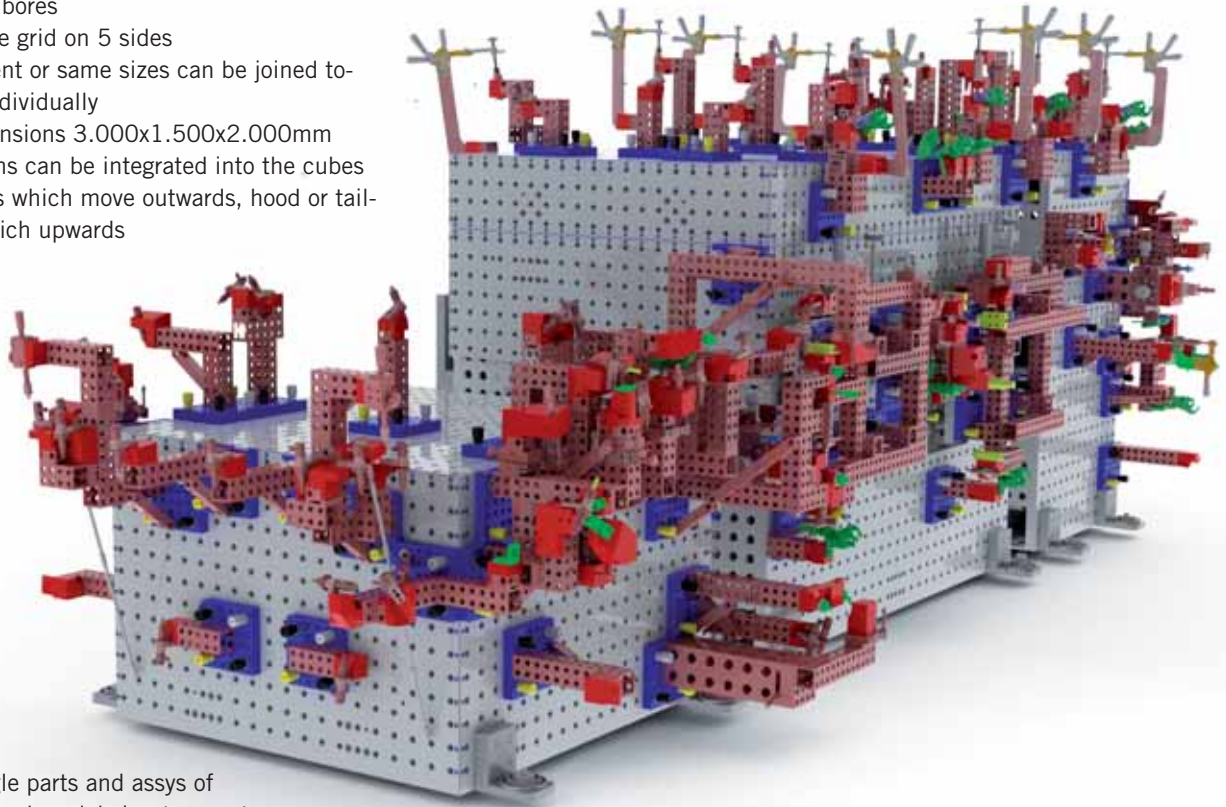

Supports for single parts and assys of various versions and models i.e. two-seater, notchback, limousine, estate, van, SUV are possible using corresponding configurations

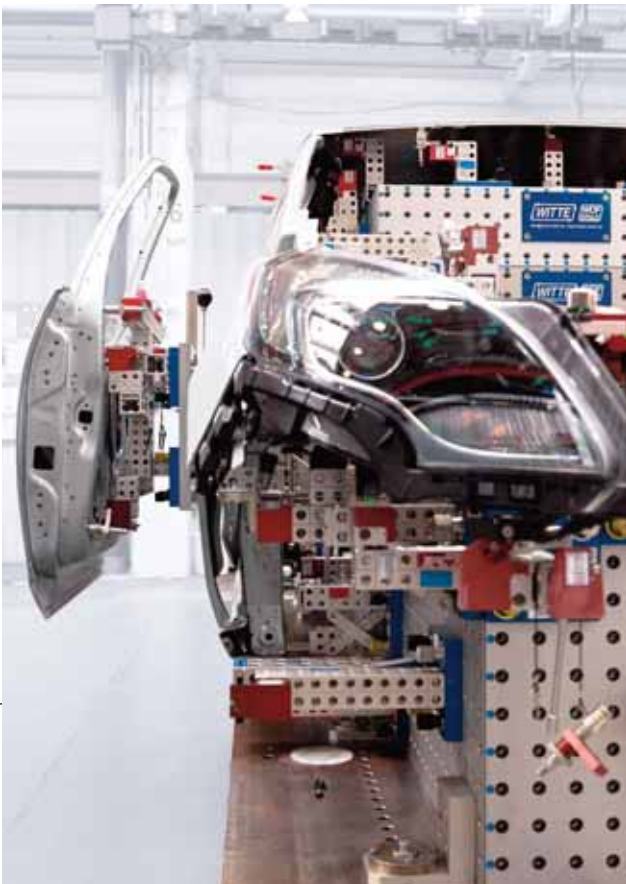

- Application example for FixBase boxes
- Single box for frontend (top)
  - Combination of several boxes to mount all parts of a body-in-white

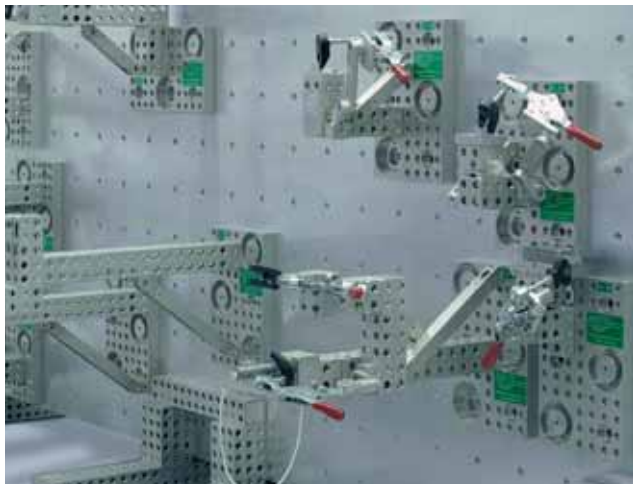

Column supports on footplates with fitted screw connection

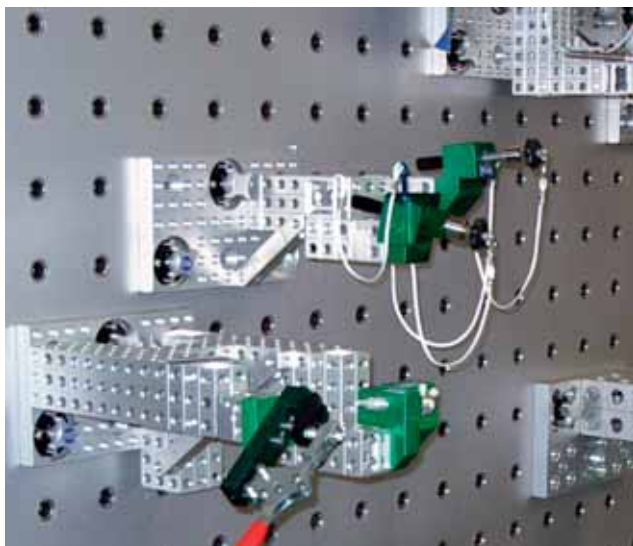

Columns connected using PWS system

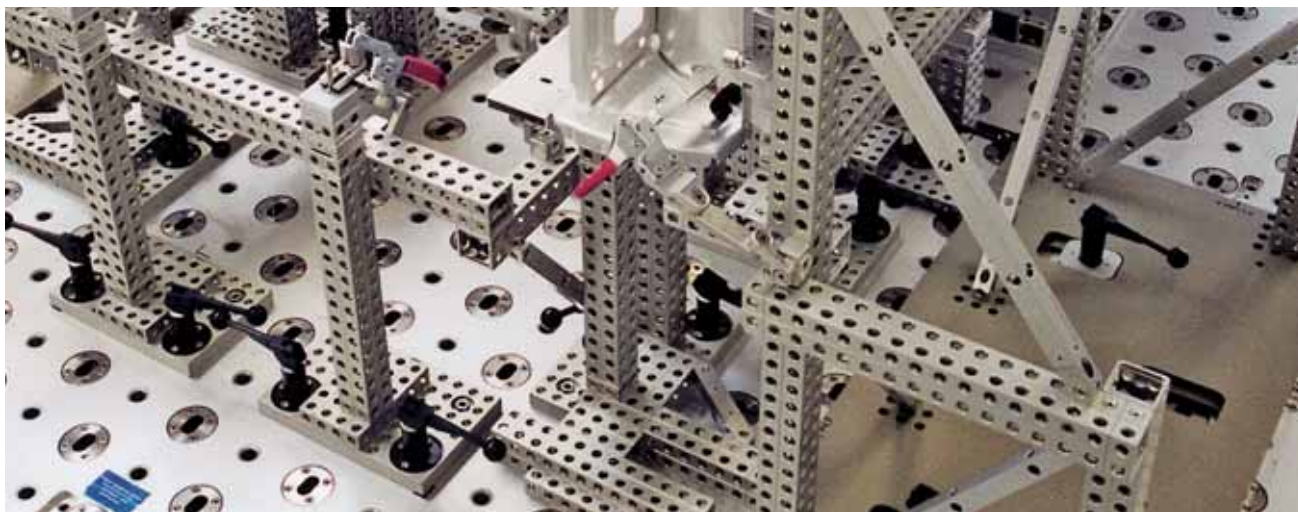

Columns connected using PPS system bayonet clamps

## Column variations

### for use on sandwich plates

Combining a grid plate (conventional or sandwich type) with exchangeable columns offers following advantages:

Use of one base for user-defined assembly of various workpieces, different assembly degrees of parts (single parts, welded groups, assemblies) different derivatives, match metal function.

Considerably less storage space is required in comparison with complete fixtures. Comprehensive accessories such as multi level trolleys, foldable, stationary or mobile storage stations and tables are available for storing column supports.

Multiple use of column supports is possible on different base plates or in different departments.

Pre measuring of supports on small measuring equipment is possible.

Different types of connection:

- Fitted screws,
- PPS (centering bolt and bayonet lever),
- PWS (clutch bolt with centering pin).

Optional simple footplates for Megalu columns or modular footplates for Classic or ECO bars are available.

The supports can be used for further functions or contact points by using folding or quick change couplings.

Longer bars on columns are supported by sharp angled struts or connected with one another when mounted.

## Mounting of foot plates

with fitting screws for grid holes

Simple and proven version.  
Two types of locators are available:

- Snug fit, floating (XY positioning)
- Without fit (only clamping)

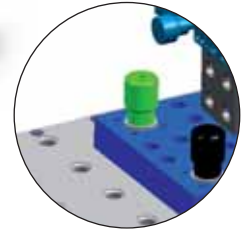

## Mounting of foot plates

with PPS-quick-clamping system

Separate positioning and fixation of footplates using a centering pin and clamp unit (with excentric lever or knob).



## Mounting of foot plates

with Witte PWS-quick-clamping system

The clutch bolt centers and clamps footplates on PWS grid plate.



**Witte FixBase®** elements can be anodized in different colours. The colour natural is standard, black (-1) is available as an alternative. Other colours on request.



**Germany**  
**Horst Witte Gerätebau**  
 Barskamp KG  
 Horndorfer Weg 26-28  
 D-21354 Bleckede  
 Germany  
 Tel.: +49 (0) 58 54/89-0  
 Fax: +49 (0) 58 54/89-40  
 E-mail:  
 info@horst-witte.de  
 www.horst-witte.de

**Asia**  
**Witte Far East Pte Ltd**  
 20 Boon Lay Way  
 # 01 - 170  
 Singapore 609967  
 Singapore  
 Tel.: +65-6248 5961  
 Fax: +65-6898 4542  
 E-mail: info@witteasia.com  
 rfq@witteasia.com  
 www.witteasia.com

**USA & Canada**  
**Witte LP**  
 2220 Northmont Pkwy, Suite 250  
 Duluth, Georgia 30096  
 USA  
 Phone: +1 (770) 982 99 32  
 Fax: +1 (770) 982 99 28  
 E-mail:  
 info@witteamerica.com  
 rfq@witteamerica.com  
 www.witteamerica.com

**Mexico**  
**Horst Witte de Mexico**  
 S.A. de C.V.  
 Linco SC  
 2 Sur 1706, Col. El Carmen  
 Puebla, 72000  
 Mexico  
 Phone:  
 +52 222893-8210  
 E-mail: esanchez@linco.com.mx  
 www.wittemexico.de

**Witte –**  
 specialists for

**Modular Fixturing  
 systems**

**Subcontracting**

**Vacuum Clamping  
 Technology**

